

YOSAN CB-350EX

Ultra Compact
CB Transceiver

Keep this user guide for future reference. Always retain your proof of purchase in case of warranty service and register your product

[Table of Contents](#)

Important information

Please read before installing or operating you CB-350 CB Radio

Safety information and Warnings

Box contents

Features

Controls and Connectors

- Front view
- Rear view
- microphone
- LCD icons & Indicators

Installation

- Caution
- Fitting the Microphone
- DC Power connection
- Antenna information & Installation
- Optional accessory

Operations

- Power On/Off
- Volume control
- Selecting a channel
- Setting the Squelch Level
- Menu mode & Menu list
 - * Roger Beep On/Off
 - * Key Beep On/Off
 - * Bright and dimmer
 - * Backlight color setting
 - * LCD Flip
- AM/FM
- EMG(BAND)
- SCAN
- ASQ
- F (Function)
 - * DX/Local
 - * 0 Raster function for poland
 - * Factory reset

Technical Specifications

Important information

Please read before installing or operating your CB-350 Radio

This radio is an advanced technology mobile C.B transceiver.

This High Tech CB radio comines the latest circuit design with microprocessor control system.

Very easily and advanced user features make it the premier radio for your mobile communications.

Safety warnings

Vehicles with air bags:

- * Do not place your radio in the area an air bag or in the air bag deployment area.
- * Air bags inflate with great forece.
- * If a radio is placed in the air bag deployment area and the air bag inflates, The radio may be propelled with great force and can cause serious injury to the occpants of the vehicle.

Potentially Explosive Atmospheres.

- * Turn you radio off when in any area with a potentially explosive atmosphere, unless it is a type especially qualified for such use(for example, by intrinsic safe approvals).
- * Sparks in such areas could cause an explosion or fire resulting in injury or even death.

Blasting caps areas

- * To avoid possible interference with blasting operations turn your radio OFF near electrical blasting caps or in a "blasting area" or in areas posted: "Turn off any two way radio." Obey all signs and instructions.

Use while driving

- * Check the laws reagrdng the use of radios while driving and always obey them.
- * In some European countries it is forbidden for the driver to keep any microphone in hands or to operate a radio during driving.
- * Some contries make a difference between mobile phones and 2 way radios. Mobile phones are only allowed to be operated in handsfree mode, while CB & commercial two way radios are still allowed even with hand microphone

Important information

Box contents

Main Radio unit
standard microphone
Owner's Manual
Microphone hanger with screws, washers.
Mounting bracket with mounting screws
DC power cord with fuse

Features

- . Transmit & Receive FM/AM 40CH
- . RF >5watt output
- . Ultra compact size
- . Signal strength meter/ Power meter
- . Multi function control for Audio Volume Channel selector and squelch level
- . AM/FM
- . Automatic Squelch System
- . Local/DX On/off function
- . Channel Scanning
- . Customized multi menu function.
- * Roger Beep tone
- * Key Beep tone
- * Selectable LCD backlight level
- * LCD Flip for versatile mounting option

Controls and Connectors

Front View

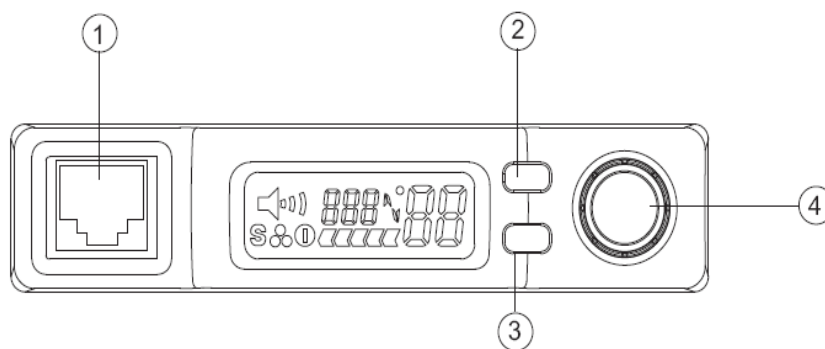

1. Wtyk mikrofonowy RJ
2. Przycisk MENU - krótkie wciśnięcie, zmiana modulacji AM/FM długie wciśnięcie
3. EMG szybka 9/19 - krótkie wciśnięcie, skanowanie kanałów długie wciśnięcie
4. Włączenie/wyłączenie radia, kontrola głośności

Controls and Connectors

Rear View

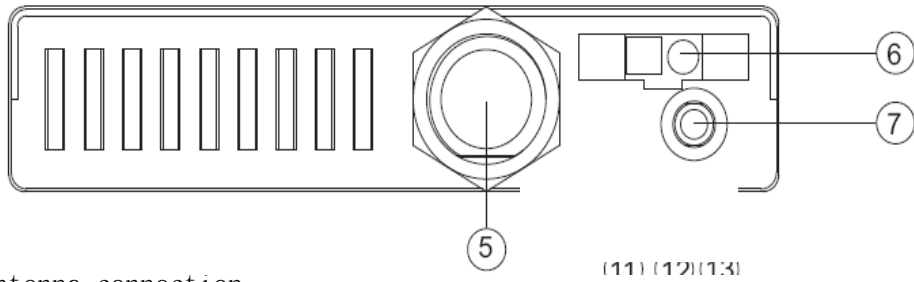

- 5. Antenna connection.
- 6. Power supply connection
- 7. 3.5mm external jack for optional 8 ohm speaker

Standard Microphone (Part No. NHM100)

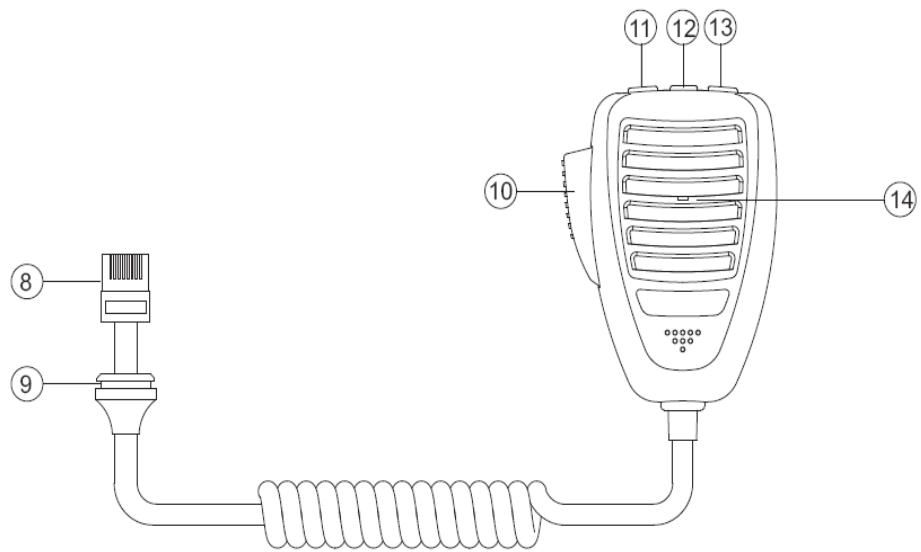

- 8. Microphone plug with RJ45 type
- 9. Microphone rubber boot
- 10. Push To Talk (PTT) button
- 11. Volume/Channel/SQ Down
- 12. Function and ASQ On/OFF
- 13. Volume/Channel/SQ Up
- 14. Condensor Mike

Controls and Connectors

LCD Icons & Indicators

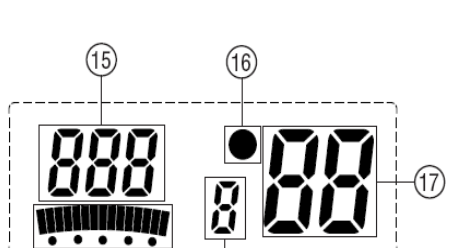

- 15. Menu function display
- 16. ASQ indicator

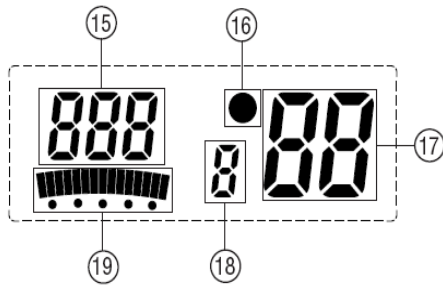

- 17. Channel, Volume and squelch level indicator
- 18. Band (A,B,C,D,E) indicator
- 19. Signal and power level indicator

Installation

CAUTION

When installing your radio in your vehicle, check that during installation you do not damage any wiring or vehicle components that may be hidden around the mounting position.

If you are unsure about how to install your radion, we suggest for optimum performance you have your radio professionally installed by a UHF specialist or Auto electrician. When installing the radio, avoid mount it close to heaters or air conditioners. Do not press the PTT or Call button before installing the antenna. Screw the mount bracket to firm surfaces.

To install the radio:

1. Fix the radio bracket in a suitable location.
2. Then fix the radio in the bracket using the thumb screws.

Note

The radio contains a built-in loud speaker, the radio can be installed 'out of the way' and an external speaker can be used as an alternative (not supplied).

Fitting the Microphone.

The microphone uses an 6 pin telephone style plug and socket.:

1. position the microphone plus so the plastic flap faces downwards, and press the plug into the socket until it 'clicks'.
2. Gently press the rubber boot into the hole surrounding the socket so that the slot around the boot fits neatly inside the rim of the entry hole.

Installation

DC Power connection

The Radio is designed for 13.8 Volt DC, negative earth installations only (i.e where the negative battery terminal connects to the chassis of the vehicle). For installation on 24 volt system an inverter (not supplied) will need to be used.

There are two possible methods of installation.

Radio stays On when the ignition is switched OFF

Connect the radio's negative(black) lead to the vehicle chassis, or directly to the batteries negative terminal.

Connect the radio's positive(red) lead via the 2 Amp fuse to the battery's positive terminal. Alternatively, the positive lead could be connected at the fuse box at a point that has +13.8Volts continuously available(preferably the battery side of the ignition switch) via the 2Amp fuse.

Radio turns OFF with the ignition switch

Connect the radio's negative(black) lead to the vehicle's chassis, or directly to the batteries negative terminal.

The radio positive(red) lead should connect to an accessory point in the vehicle's fuse box via the 2Amp fuse.

Antenna information

For radio communications, the antenna is of critical importance, to maximize your outputpower and receiver sensitivity.

The transceiver accepts a 50 ohm antenna and less than 1:1.5 of voltage standing wave ratio (VSWR).

High SWR values not only may damage the transceiver but also to TVI or BCI problems.

Antenna installation

1. Connect the antenna to the rear antenna socket using a PL259 coaxial connector.
 2. To obtain maximum performance from the radio, select a high quality antenna and mount it in a good location.
- Do not press the PTT button before installing the antenna.

Optional accessory

If required you may install an external (8 ohm, max 5watt power) speaker fitted with a 3.5mm plug (not supplied)

There is a jack located on the rear of the radio and on the UHF 300 there is an additional jack on the side of the remote head unit.

Operations

Power On/Off

Press and hold the power/Channel selector for 2 seconds.

The default channel is set at 9CH, FM.

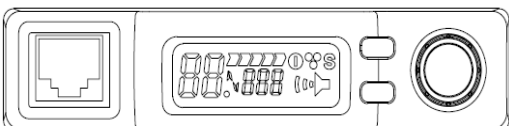

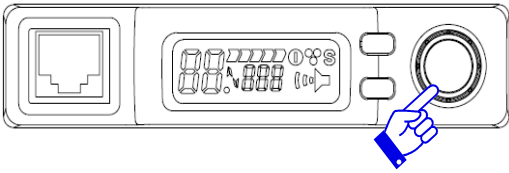

Volume control

Turn the channel selector clockwise to adjust the sound level for comfortable reception. The volume step of 1 to 32.

On the microphone push the up or down buttons to increase or decrease the volume, if held down the volume will increase or decrease quickly.

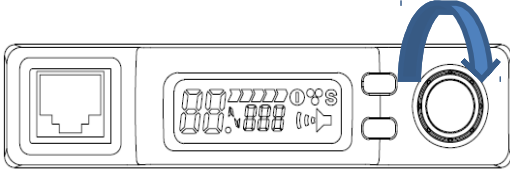

Selecting a channel

Press power/channel once. The channel digits display flashes.

Select the channel by rotating the channel up or channel down.

On the microphone push the up or down buttons to increase or decrease the volume, if held down the volume will increase or decrease quickly.

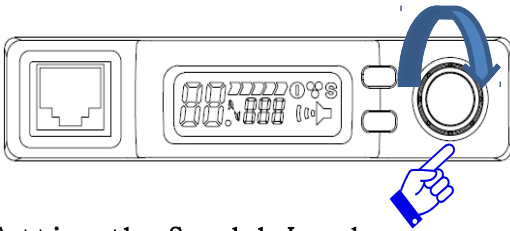

Setting the Squelch Level

1. Press power/channel 2 times. The current squelch level will flash.
2. Select the channel by rotating the squelch (sql) level up or channel down.

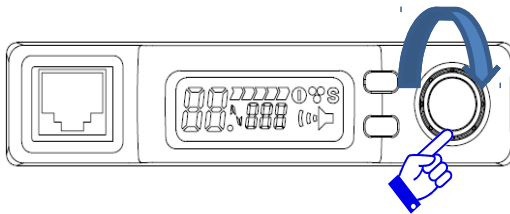

The radio has 32 preset (off - 31) squelch level.

Off - Squelch open

1- Max sensitivity (Min. squelch)

31- Min. sensitivity (Max/Tight squelch)

Operations

Menu

The Menu feature provides a convenient method of customizing some of the radio's functions. The following menu options are available.

Note that some items are only available on certain channels.

1. Press and Menu/AF button. The first menu function displayed.

2. Press the Menu/AF button to cycle through each available function.
After the last function has been selected, the cycle return to the beginning.
3. Rotate the cahnnel knob to alter the parameters of the selected function.
4. Press and hold Menu/Monitor button to exit and store any changes.

Menu list

- * Use the channel knob to change the value of each setting.
- * If a button is not pressed within 8 seconds the radio will automatically exit the menu mode.
- * Please see below menu mode

Function	Step	Display	Default
Roger Beep	On		Off
	Off		
Key Beep Tone	On		ON
	Off		
Bright or Dimmer	On		BRT
	Off		
Backlight LED color	7 color		Green
Flip	On		Off
	Off		

Roger Beep

This function emits a beep on the communication party to inform the transmission is finished.

Key Beep

The Beep tone emits a tone when you press any of the buttons on the microphone (except PTT button)

Operations

Bright and Dimmer

You can reduce the brightness of the LCD backlight to be more comfortable while driving at night.

Backlight 7 color

you can select from seven color options for the LCD backlight.

The seven options are white, red, yellow, purple, cyan, blue and green.

Flip LCD

You can flip the display for a convenient mounting position.

AM/FM

You can select AM or FM modulation by press hold the AM/FM button.

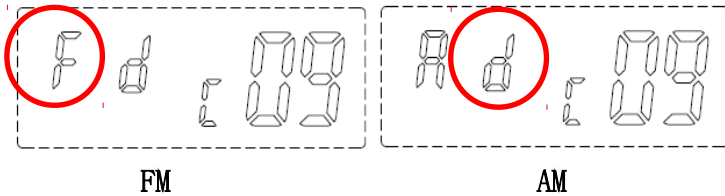

EMG

This function changed from EMG to Band selector.

The MJ50 has 5 band (A,B,C,D,E).

Press EMG button and change 5 band.

Scan

Your CB-350 incorporates a scanning feature. The MJ50 will scan through all 40 channels and will stop at any BUSY channel. It will stay on that channel until seven seconds after conversation has stopped and then it will resume scanning.

- * To start scanning turn on the power first and adjust the volume and squelch.
- * Press hold the SCAN button to start scanning.
- * Display and the unit will start scanning.
- * If you want stop scanning you can push hold Scan button again or press the Push to talk switch.

This will shut off the scanning function and transmit on that channel.

ASQ

The ASQ is a feature that allows the radio to keep the receiving mode without white noise and to receive the incoming signal stronger than fixed level.

It is level located 3dB below maximum usable sensitivity.

Normal squelch control system was RF level controlled but the ASQ controlled system is with noise filter amplifier.

Operations

So more actually controlled of squelch system in the many unless noise condition.

- * Press hold ASQ button on the microphone.
- * The word circle dot will appear in the LCD.
- * If you want disable ASQ you can push hold ASQ button again.

F (FUN)

This F button can control two SUB function is sequence.

1) DX/LOCAL

The DX feature allows long distance communication for some season.
The DX setting condition is maximum user receiving sensitivity condition.
When DX is not selected, you can communicate with local area.

- * Press F button on the microphone and the word "Fun" will appear in the LCD.
- * To change press menu button on the front panel.
- * The word change from "d" to "L". It is local mode set.
- * If you want change from local to DX. Again press F + MENU button.

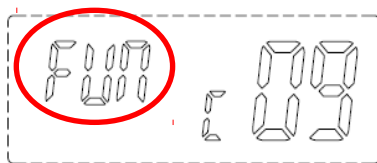

Press F key

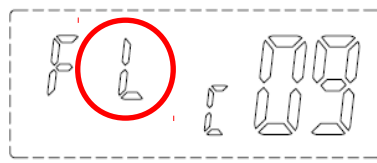

Change to Local

2) Change of Poland frequency

The -5KHz feature allows the user to Poland frequency.
Press F on the microphone and EMG button and will be change of display as below.
The -5KHz a few second appear. It is poland frequency fixed.
The 1 channel normal frequency is 26.965MHz but poland frequency is 26.960MHz.

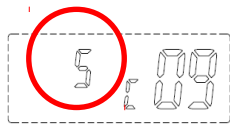

Set to 1 channel 26.965MHz



Set to 1 channel 26.960MHz

Factory Reset

Turn Radio off press and hold both MENU and EMG buttons then turn radio on, this will reset all menu settings to defaults as listed on menu page.

Technical Specifications

1. General	
Transmitter	Crystal controlled PLL Synthesizer
Receiver	Double conversion, Super heterodyne system
Operating voltage	DC 13.8V
Operating Temperature	-10 °C ~ +50 °C
Channel step	10KHz
Dimension	83(D) x 99(W) x 24(H) mm.

Weight	150g without Accessories
External speaker Jack	3.5pi mono with 8 ohm
Antenna connector	CH-239 M type
Microphone	RJ45 6 Pin

2. Transmitter

Output RF power	Less than 4 Watts
Frequency range	26.965 to 27.405MHz
Frequency Error	+/-600 Hz
Modulation Capablity	FM : 2.0KHz AM: 85%
Mic Sensitivity	8mV at 1250Hz, 1.5KHz

3. Receiver

Sensitivity at 12dB SINAD	FM: -120dBm AM: -118dBm
Squelch	-47dBm
Auto Squelch Sensitivity	-123dBm
S/N ratio	40dB
Distortion	Less than 5% at 2.0V output