



MIDLAND

2024 CATALOG



***MOVING
COMMUNICATION***

AWARDS AND HONORS

Midland, an Italian company always focused on design, has received several awards throughout its history.

One of these is the **Red Dot Award**, one of the most important in the International Design field where a pool of experts analyses over 6,500 products focusing on the complementarity between design and quality.

Midland has won four awards in the last 3 years in the **Product Design category** of the **Red Dot Award**: the **XT70 Pro**, **777 Pro** and **G9 Pro** radios and the **BT Rush** intercom.



OUR TALE OF INNOVATION, FOR OVER 60 YEARS.

1959

Founding year.

1977

1st certified CB Radio on the European market.

1998

1st LPD Walkie Talkie in the world.

2008

1st Bike to Bike Intercom in the world.

2013

1st Action Cam with Wi-Fi remote control.

2016

1st App that exceeds the limits of communication between riders.

2018

1st Digital CB Mike.

2019

Cb Talk App, the largest community of drivers.

2023

R1 Mesh, the most competitive and innovative
Mesh & Bluetooth motorcycle intercom system on the market.

MIDLAND NEVER STOPS.

INDEX



RADIOS

- 4 Which radio to choose
- 6 Radio for professional use
 - 8 G18 Pro
 - 9 G15 Pro
 - 10 G13 | G13 Blaze
 - 12 G11 Pro
 - 13 G10 Pro

- 14 777 Pro
- 16 G9Pro
- 17 G7 Pro
- 18 G9 | G7 Pro Work Edition
- 20 XT70 Pro | XT70 Pro H&W
- 21 XT50 Pro | XT50 Pro H&W
- 22 XT30 Pro | XT10 Pro
- 23 XT10 Pro Multicolor Pack
- 24 XT5
- 25 Talker XT Series
- 27 GB1-R

28 VHF/UHF radios

Amateur

- 29 CT 990-EB
- 30 CT 590 S | Blaze

Marine

- 32 Arctic

33 Accessories

40 Overview tables



CB RADIOS

44 The CB radio best suited for your needs

- 46 Alan 42 DS
- 48 Midland 88
- 50 Alan 48 Pro
- 51 Alan 78 Pro
- 52 Alan Quarantotto
- 53 Alan Sessantotto
- 55 M-30
- 56 M-5
- 57 Kit Camper
- 58 M-Mini Usb
- 59 M Zero Plus | Alan 100 Plus B
- 60 Dual Mike Wireless
- 61 CB Handsfree Kit
- 62 PTT Dual
- 63 Dual Headset | Bluetooth microphone accessories

64 CB accessories

75 Overview tables



VIDEO CAMERAS

78 Which video camera to choose

Wild Cam

- 80 Wild Guardian Wi-Fi
- 81 Wild Guardian

Dash Cam

- 82 Bike Guardian Pro
- 84 Bike Guardian
- 85 Truck Guardian Wired
- 86 Truck Guardian Pro
- 89 Wireless RV Cam

Action Cam

- 91 H9 Pro
- 92 H5 Pro
- 93 H3+

Web Cam

- 94 W199 | Follow U

95 Bicycle and motorcycle handlebar smartphone holders

96 Overview tables



POWERBANK

- 99 ER300
- 100 ER250 BT
- 101 ER200

INTERCOMMS

102 Midland motorcycle intercoms

- 103 BTX2 Pro S | BTX1 Pro | BTGO Uni



MIDLAND®

RADIOS

**BUSINESS RADIOS
WALKIE TALKIE
AMATEUR VHF/UHF
MARINE VHF**

WHY A RADIO AND WHICH ONE TO CHOOSE.

Usually, emergency and security situations are associated with radios: first aid, police, firefighters, civil protection. These are just some examples of professional figures that come to mind when we talk about radios.

What if we told you that they are not the only radio users? What if we told you there are others? Radios are widely used in places that have to manage the public and require rapid communication tools on wide surfaces, for example: department stores, shopping centres, restaurants, hotels and seaside resorts.

FAMILY RADIOS



Looking for an easy and immediate radio,
just right for your family?

XT5

XT10

XT10 Pro | XT10 Pro Multicolor

RADIO FOR BUSINESS



Indestructible models
for the harshest environments:

G11 Pro

G13

G15 Pro

G18 Pro

G7 | G9 Pro Work Edition



Do you have a store,
a club or a hotel?

777 Pro

G10 Pro

Advantages:

- Radios are not afraid of shocks, low or high temperatures. They are made to last over time.
- Signal coverage: radios always have signal, anywhere (there are no “grey areas” such as in basements, in the mountains, etc.).
- Speed in communications. It is not important to know the telephone numbers of all interlocutors.

Just press a button: PTT.

PMR446: contribution of €12 and declaration of activity start abolished.

The decree issued on 17/7/2020 which sanctions the liberalization of the PMR446 band has finally become law. Thanks to Law No. 120 of 11 September 2020, it is now no longer necessary to fill in and submit the self-certification to the Italian Ispettorato Territoriale and pay an annual contribution of €12. What are you waiting for? Buy your PMR446 radio and use it without wasting more time, as in the rest of Europe.

RADIOS FOR YOUR PASSIONS



Do you like travelling or outdoor activities?

XT Pro Line

XT Line

GB1-R



Are you a hunter or do you like tactical games such as softair or paintball?

G7 Pro

G9 Pro

G13

I WANT THE BEST

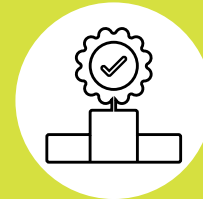

If you're looking for the most advanced technology, these are the right radios for you.

G15 Pro

G18 Pro

THE PROFESSIONAL-LEVEL RADIO SYSTEM

Choosing a radio communication system for your business means embracing the reliability, competitiveness, efficiency and durability that only this instrument can provide.



RELIABILITY

In retail contexts, such as nightclubs and restaurants, device reliability is crucial to ensure workplace safety and efficiency. Breakdowns in communication can pose a risk to workers, customers and the premises. Key communication challenges include coverage, device reliability, and breakdowns in connectivity between employees. A proactive approach to radio maintenance is essential to prevent interruptions to operations and downtime.



COMPETITIVITY

The key to ensure your store remains competitive is to maintain effective communication within your team. To this end, the use of a radio system is fundamental as it significantly improves communications between members of your work group. It creates a constant flow of real-time information, ensuring your staff are always optimally informed and fully coordinated. By employing an efficient radio system, your sales outlet can respond more effectively to your customers' needs and market changes, which ultimately ensures your business maintains its competitive edge.





EFFICIENCY

The key to increasing sales efficiency is a swift and immediate communication between your sales and warehouse teams. By employing a radio system you can achieve this with ease. The radio allows for instant, real-time communication between teams, meaning you can respond promptly to customer needs and provide a swifter, more efficient and more effective service. Radio communication is the ideal tool to optimize sales procedures and improve customer experience.

SAVING

In general, using a radio can also yield notable cost savings, allowing for a quick return on investment and significant annual savings, which will be more significant as the number of workers and hourly costs increase. So the decision to employ a radio system represents a truly cost-effective investment for any business.



RESISTANCE

The durability of our radio system represents its major strength, providing an assurance of continuity of communication whatever the situation. Whether its adverse weather conditions or the potential for service interruptions, your communications will remain unaffected, ensuring your operations remain safe and consistent.

INTERCONNECTIVITY AND COVERAGE

Interconnectivity and reliable coverage are key features of a business radio system. A radio communication system guarantees maximum coverage – even in areas where the signal may be weak or absent. This allows your team to communicate in complete safety regardless of circumstances. The radio system thus becomes a reliable ally to ensure uninterrupted and secure communications in any operational context.

DIFFERENT USES

Business radio systems are versatile and used in many different sectors: hotels, restaurants, nightclubs, installations, beachside establishments, swimming pools, campsites, golf clubs and nature reserves. They provide a valuable tool for enhancing communication, increasing efficiency and ensuring safety in any context.

G18 PRO

The IP67 indestructible walkie talkie becomes professional and exceeds military reliability standards.



G18 Pro, the most advanced model of the PMR446 walkie talkie range becomes **professional**. It keeps the **rugged frame** built to military standards, a high visibility screen, **IP67 certification** as dust and water resistant, and is capable of withstanding the harshest environments.

It adds the **RRM channel function** to the previous model, a fast recall to the Rete Radio Montana channel, programmable via software.

G18 Pro meets all types of needs and uses.

Version: PMR446
Colour: Black
Channels: 16+83 pre-set
Tones: 50 CTCSS + 105 DCS normal/inverted

Features

- Extended frequency band: from 446.00625 to 446.19375 MHz
- Aluminium chassis
- IP67 certified
- Output power: ≤500mW ERP
- Channel spacing: 12.5 kHz
- Military Standard MIL-STD 810G Compliance
- Rete Radio Montana (only for Italy)
- Channel scanning
- Voice announcement
- Roger Beep, Auto power save
- Monitor
- Squelch
- Vox
- FM Radio, Scrambler and Comander
- Power supply: Li-Ion 1600 mAh battery pack
- 2-pin Motorola accessory socket

Packaging and codes

Radio, desktop charger, wall adapter, rechargeable Li-Ion battery pack (1600 mAh), belt clip.
code C1145.02



■ **Multi CA PB-G15 Pro C1573**
 6 position multicharger (optional)

Single desktop charger included in the pack



Export version 5W

Programming software PRG-G15 - C1131

Customisation of channels and frequencies, activation/deactivation of specific functions.

99 CHANNELS 16+83 PREPROG	155 CTCSS+DCS TONES	 WATERPROOF IP67	 SCAN	 VOICE ANNOUNCEMENT	 FM RADIO
 SCRAMBLER	 COMANDER	 VOX	 ROGER BEEP	 RETE RADIO MONTANA	 BATTERY PACK
 PROGRAMMABLE	 2-PIN MOTOROLA				

G15 PRO

The indestructible IP67.



The **G15 Pro** is the leading walkie talkie in the professional category. With a durable aluminium chassis and truly high-performance water protection, take it wherever you want and mistreat it too. You will always find it there, next to you, ready to help you in your endeavours.

Version: PMR446
Colour: Black
Channels: 16 + 16 pre-set
Tones: 50 CTCSS + 105 DCS

Features

- 8 new PMR446 channels
- Extended frequency band: from 446.00625 to 446.19375 MHz
- Aluminium chassis
- IP67 certified
- 16/32 channel quick selection
- Output power: ≤500mW ERP
- Channel spacing: 12.5 kHz
- Channel scanning
- Voice announcement
- Side tone: end of transmission tone silencer
- Roger Beep
- Auto power save
- Monitor, Squelch, Vox
- Power supply: Li-Ion 1600 mAh battery pack
- 2-pin Motorola accessory socket

Packaging and codes

Radio, desktop charger, wall adapter, rechargeable Li-Ion battery pack (1600 mAh), belt clip.
code C1127.03

Export version 5W



■ **Multi CA PB-G15 Pro C1573**
6 position multicharger (optional)

Single desktop charger included in the pack

Programming software PRG-G15 - C1131

Customisation of channels and frequencies, activation/deactivation of specific functions.

32 CHANNELS 16+16 PREPROG	155 CTCSS+DCS TONES	 WATERPROOF IP67	 SCAN	 VOICE ANNOUNCEMENT	 VOX
 PROGRAMMABLE	 ROGER BEEP	 BATTERY PACK	 2-PIN MOTOROLA		

G13

Up to 40 hours of battery life, with scrambler.



G13 is the model in the MIDLAND line dedicated to the world of hunting. Those who practice hunting activities must be able to count on a reliable, versatile and long-lasting radio. If you think you're a hunter and you're looking for a walkie talkie that will always allow you to signal your presence in the shooting area... add the new G13 portable transceiver to your equipment. **8 new PMR446 channels ensure a low level of congestion (traffic-free radio spectrum).**

Version: PMR446
Colour: Black
 Mimetic Mossy Oak orange
Channels: 16 + 83 pre-set
Tones: 50 CTCSS + 106 DCS normal/inverted

Features

- 8 new PMR446 channels
- Extended frequency band: from 446.00625 to 446.19375 MHz
- High efficiency, 2,600mAh Li-ion battery (autonomy up to 40 hours)
- High-performance loudspeaker
- LCD display with backlighting
- Aluminium chassis
- IPX4 watertightness
- LIGHT keyboard (3 keys only)
- VOX, Scan, Dual Watch, Monitor
- Scrambler (via optional programming software)
- 2-pin Kenwood accessory socket

Packaging and codes

Radio, desktop charger, wall adapter, 2600mAh Li-Ion rechargeable battery pack, belt clip.

code C1462 (Black)
code C1462.03 (Blaze)

Export version: 5W



■ **Multi CA PB-G13 C1541.01**
 4 position multicharger (optional)

Single desktop charger included in the pack



■ **Discover the High Performance accessories page 35**

Programming software

PRG 10 - C974.01

Customisation of channels and frequencies, activation/deactivation of specific functions.

99 CHANNELS 16+83 PREPROG	156 CTCSS+DCS TONES	 WEATHERPROOF IPX4	 SCAN	 SCRAMBLER	 VOX
 DUAL WATCH	 ROGER BEEP	 BATTERY PACK 40H	 RETE RADIO MONTANA	 PROGRAMMABLE	 2-PIN KENWOOD

Discover the video



G13

**THE RADIO DEDICATED TO THE HUNTING WORLD
AND THE PROFESSIONAL WORLD.**





G11 PRO

For noisy environments.

Single desktop charger included in the pack



G11 Pro is a device with attention to the smallest details to guarantee excellent performance, thanks also to its incomparable audio for high quality communications. Its sturdy mechanical structure and its metal chassis make it a very reliable transceiver and suitable in various situations.

8 new PMR446 channels ensure a low level of congestion (traffic-free radio spectrum).

Version: PMR446
Colour: Black
Channels: 16 + 16 pre-set
Tones: 50 CTCSS + 105 DCS normal/inverted

Features

- Aluminium chassis
- 8 new PMR446 channels
- Extended frequency band: from 446.00625 to 446.19375 MHz
- Output power: 500mW
- 16/32 channel quick selection
- Voice announcement
- Channel spacing: 12,5 kHz
- VOX function (hands-free transmission)
- Channel scanning, function button beeps
- Roger beep
- Monitor
- TOT (Time Out Timer)
- Auto power save
- Power supply: 1600 mAh Li-Ion battery pack
- 2-pin Kenwood accessory socket

Packaging and codes

Radio, desktop charger, wall adapter, rechargeable Li-Ion battery pack (1600 mAh), belt clip.
code C966.06

Export version: 5W



■ **Discover the High Performance accessories page 35**

Programming software PRG 10 - C974.01

Customisation of channels and frequencies, activation/deactivation of specific functions.

Available only at midlandeurope.com

Perfect solutions for small work teams who need to communicate hands-free and thus optimize efficiency at work



TEAMWORK 2 KIT

2 G10 Pro radios, 2 belt clips, 2 desktop chargers, 2 wall adapters and 2 MA21 LKi earpieces.

TEAMWORK 4 KIT

4 G10 Pro radios, 4 belt clips, 1 4-port desktop charger.



G10 PRO

Simple and strong radio.

Single desktop charger included in the pack



Clean and compact design, technical performance, perfect also for professional communications in low-complexity environments, this is the **Midland G10 Pro** walkie talkie. Thanks to an immediate signalling of the selected channel and the programming software, the **G10 Pro** will be the perfect partner for all your needs. An entry level with great performance with **8 new PMR446 channels guaranteeing a low level of congestion (radio spectrum free from traffic).**

Version: PMR446
Colour: Black
Channels: 16 + 16 pre-set
Tones: 50 CTCSS + 116 DCS normal/ inverted

Features

- 8 new PMR446 channels
- Extended frequency band: from 446.00625 to 446.19375 MHz
- Output power: 500mW
- Channel spacing: 12.5 kHz
- 16/32 channel quick selection
- Channel scanning
- Voice announcement
- Function button beeps
- Monitor
- Auto power save
- Power supply: 1200 mAh Li-Ion battery pack
- 2-pin Kenwood accessory socket

Packaging and codes

Radio, desktop charger, wall adapter, Li-Ion rechargeable battery pack (1200 mAh), belt clip. **code C1107.04**

Export version: 5W



- **Multi CA PB-G13 C1541.01**
4 position multicharger (optional)
- **Discover the High Performance accessories**
page 35

Programming software
PRG 10 - C974.01

Customisation of channels and frequencies, activation/deactivation of specific functions.

<p>32</p> <p>CHANNELS 16+16 PREPROG</p>	<p>166</p> <p>CTCSS+DCS TONES</p>	<p>SCAN</p>	<p>VOICE ANNOUNCEMENT</p>	<p>BATTERY PACK</p>	<p>PROGRAMMABLE</p>
<p>2-PIN KENWOOD</p>					

777 PRO

The coolest walkie talkie for small business.

Range*



* Depends on usage conditions



777 Pro Limited Edition

Elegant and handy case complete with a rich range of accessories.

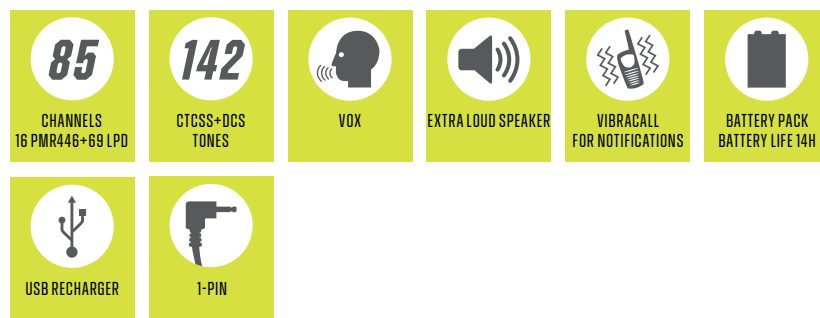

When the night comes on, rhythm dictates the laws of the evening and the fun doesn't stop, but the unexpected can always happen.

What for some is an opportunity for entertainment, for others is a serious and responsible profession.

For this purpose you need a reliable radio but at the same time elegant and aesthetically refined radio, to fulfil its duty in the best possible way, like the **777 Pro**, winner of the prestigious international **REDDOT DESIGN AWARDS**.

Wide black display, EDD™, with white lighting, **8 new PMR446 channels that ensure a low level of congestion (traffic-free radio spectrum).**

Version: Dual band PMR446/LPD
Colour: Black
Channels: 16 PMR446 + 69 LPD
Tones: 38 CTCSS + 104 DCS

Features

- 8 new PMR446 channels
- Extended frequency band: from 446.00625 to 446.19375 MHz
- Black EDD™ display with white lighting, 50% wider than the previous model
- Super-powerful loudspeaker
- 1000mAh Li-Ion battery pack (up to 14 hours' autonomy)
- Recharge via micro USB side socket or use the desktop charger
- Vibracall function for notifications even in noisy environments
- VOX function with 9 selectable levels
- 38 CTCSS tones / 104 DCS codes
- Earpiece socket with 1 3.5mm pin in the upper part for greater wearability

Packaging and codes

Twin pack box:

2 radios with belt clip, 1 dual desktop charger, 2 Li-Ion 1000mAh rechargeable battery packs, micro USB cable.

code C1365

Limited Edition case:

2 radios with belt clip, 1 dual desktop charger, 2 Li-Ion 1000mAh rechargeable battery packs, micro USB cable, 1 wall charger, 2 MA21-777 Pro microphones, 2 neck straps.

code C1365.01

Export version 2W

Discover the video



G9 PRO

The world's best-selling outdoor radio.

Discover the video



Midland G9 Pro is the radio used in any outdoor context. With a 30% larger display, audio improved by 30%, a more powerful antenna and a dual PTT that allows you to instantly select high and low power, your communication becomes easier and more fun. **G9 Pro** is the first to introduce the **8 new frequencies of the PMR 446 band**, which are freely used all over Europe, for communications free of overlaps and congestion by other users.

Among the optional accessories you can choose the lithium battery pack to make it even lighter and more durable.

Version: Dual band PMR446/LPD
Colour: Black /Mimetic Mossy Oak®
Channels: 16 + 16 pre-set PMR446 - 69 LPD
Tones: 38 CTCSS + 104 DCS

Features

- 8 new PMR446 channels
- Extended frequency band: from 446.00625 to 446.19375 MHz
- Weatherproof IPX4
- High-performance loudspeaker
- Wide LCD display (30% wider than the previous version)
- Weatherproof IPX4
- Double PTT button for high/low power
- Emergency function
- Out of range function
- VOX with TalkBack™
- Side tone: end of transmission tone silencer
- Vibracall, Dual Watch
- Keypad lock, Scan, Monitor
- TOT (Time Out Timer)
- Low battery indicator and power save
- 12cm antenna to make the most of the full radio transmission power
- High-low power selection
- Call button with 5 available tones
- Roger Beep: end of call tone (can be deactivated)
- Power supply: batteries or battery pack Ni-MH/Li-Ion (optional)
- 2-pin accessory socket
- Compatible wall charger: MW904

Packaging and codes

G9 Pro Box Black and Mimetic

- Radio, desktop charger, wall adapter, 4 1800 mAh rechargeable AA batteries, belt clip.

code C1385 Black

code C1385.01 Mimetic

G9 Pro Box White Storm

- Radio, desktop charger, wall adapter, 1200 mAh Lithium battery, belt clip

code C1385.08

Export version 5W



G7 PRO

Perfect combination of simplicity and efficiency.

Discover the video



Midland G7 Pro is the radio for those who love outdoor activities. Hiking, airsoft, climbing, hunting are just a few examples of the perfect use of this walkie talkie. A compact and elegant design that always accompanies you in your passions. Among the optional accessories you can choose the lithium battery pack to make it even lighter and more durable.

8 new PMR446 channels ensure a low level of congestion (traffic-free radio spectrum).

Version: Dual band PMR446/LPD
PMR446

Colour: Grey/Black - Mimetic Mossy Oak

Channels: 16 PMR446 - 69 LPD

Tones: 38 CTCSS + 104 DCS

Features

- 8 new PMR446 channels
- Extended frequency band: from 446.00625 to 446.19375 MHz
- Dual watch: to monitor 2 different channels at the same time
- Double PTT hi/low power
- Vibracall, Keypad lock
- Auto power save: automatic battery saving
- Low battery indicator
- 3 types of VOX (Vox standard - Vox Baby-Sitting - Vox Bike) adjustable to 2 levels, for hands-free communication
- CALL with 5 different melodies, SCAN
- Power supply: battery pack Ni-MH 800 mAh or Li-Ion 1200 mAh (optional), 4 AA batteries
- Roger beep end call switchable
- 2-pin accessory socket
- Compatible wall charger: MW 904

Packaging and codes

G7 Pro Box Black and Mimetic - single pack box

- Radio, wall adapter, 4 rechargeable Ni-MH AA 1.2V 1800 mAh batteries, belt clip.

code **C1090.14 Black**

code **C1090.15 Mimetic**

Box G7 Pro White Storm - single pack box

- Radio, wall adapter, 1200 mAh Lithium battery, belt clip.

code **C1090.20**

G7 Pro Box Black - twin pack box

- 2 radios, double desktop charger, wall adapter, 2 800 mAh battery packs, belt clip.

code **C1090.13**

Export version 3W



*An indestructible case designed for the harshest environments.
Earphones, desktop chargers and rechargeable batteries are included in a kit
that can be easily carried anywhere.*



G9 PRO

2 or 4 radios Work Edition.

Packaging and codes

2 transceivers Work Edition:

2 G9 Pro transceivers with belt clips, 8 1800 AA Ni-MH rechargeable batteries, 2 desktop chargers, 2 wall power supplies, 2 MA24-L microphones.

code C1385.04 Black dual band

4 transceivers Work Edition:

4 G9 Pro transceivers with belt clips, 16 1800 AA Ni-MH rechargeable batteries, 4 desktop chargers, 4 wall power supplies, 4 MA24-L microphones.

code C1385.05 Black dual band

G7 PRO

2 or 4 radios Work Edition.

Packaging and codes

2 transceivers Work Edition:

2 G7 Pro transceivers with belt clips, 1 double desktop charger with wall adapter, 2 800mAH battery packs, 2 MA24-L microphones.

code C1090.18 Black dual band

4 transceivers Work Edition:

4 G7 Pro transceivers with belt clips, 2 double desktop chargers with wall adapters, 4 800 mAH battery packs, 4 MA24-L microphones.

code C1090.19 Black dual band



Discover the video



XT PRO SERIES

WALKIE TALKIE FOR THE OUTDOOR.

XT70 PRO | XT70 PRO HOBBY & WORK

12 Km range*, with earphones, volume knob and quick desktop charger.



■ **XT70 Pro Hobby & Work**
The full optional case



XT70 Pro



XT70 Pro Hobby&Work

The **Pro** version of the **XT70** has an admirable technical upgrade. Compared to the previous one, we find the PMR446 extended band, rain protection (Waterproof IPX4), adjustable squelch and 9 VOX levels. Winner of the Red Dot award in the Design category.

Version: PMR446/LPD
Colour: Blister Black/Metallic Dark Grey
 Case Black/Orange
Channels: 16 + 16 pre-programmed PMR446 - 69 LPD
Tones: 38 CTCSS + 104 DCS

Features

- Waterproof IPX4
- Emergency call function
- Side tone: end of transmission tone silencer
- Wide liquid crystal display with backlight
- Low battery indicator
- Auto power save
- CALL button with 10 selectable tones
- Rete Radio Montana (available only in Italy)
- Typical autonomy up to 12 hours with the 700mAh (Ni-MH) battery pack supplied
- 3 hours' quick charger
- Monitor function, Baby sitter function
- Volume adjusting knob
- Channel selection buttons
- Automatic or manual out of range
- SCAN, VibraCALL, Dual Watch function
- Squelch (9 levels), Keyboard lock
- High/low power selection (PMR band)
- Roger BEEP that can be switched off
- VOX for hands-free communications with 9 selectable levels
- 2-pin accessory jack

Packaging and codes

Blister:

2 radios, 2 belt clips, 1 double quick desktop charger, 2 700mAh rechargeable battery packs, 1 wall power supply
code C1465

Case:

2 radios, 2 belt clips, 2 Ni-Mh 700mAh rechargeable battery packs, 1 wall power supply, 1 double desk charger, 2 MA21-Li microphones, 2 neck collars.
code C1465.01

Export 4W version

101 CHANNELS 32 PMR446+69 LPD	142 CTCSS+DCS TONES	 WATERPROOF IPX4	 DISPLAY NIGHT	 VOX 9 LEVELS	 SIDE TONE
 CALL 5 TONES	 OUT OF RANGE	 BABY SITTER	 HIGH/LOW POWER	 VIBRACALL	 SCAN
 CH RRM RETE RADIO MONTANA	 BATTERY PACK BATTERY LIFE 18H	 USB CHARGE	 2-PIN		

XT50 PRO | XT50 PRO HOBBY & WORK

8 Km range*, with earphones.



■ **XT50 Pro Hobby & Work**
The full optional case!



XT50 Pro

XT50 Pro Hobby&Work

The features previously proposed by the XT50 and XT60 models converge in the **XT50 Pro**; to these are added further functions and a body always in strong colours!

The PMR446 band is extended and includes the special RRM channel (Rete Radio Montana); the chassis is not afraid of humidity (Waterproof IPX2).

Version: PMR446/LPD
Colour: Black/Blue
 Case Black/Yellow
Channels: 16 PMR446 - 69 LPD
Tones: 38 CTCSS + 83 DCS

Features

- Waterproof IPX2
- Side tone: end of transmission tone silencer
- Liquid crystal display with backlight
- Low battery indicator
- Auto power save: automatic battery saving circuit
- CALL button
- Rete Radio Montana (available only in Italy)
- Typical autonomy up to 12 hours
- SCAN function
- Monitor function
- Keypad lock
- High/low power selection
- Roger Beep that can be switched off
- VOX for hands-free communications with 6 selectable levels
- 2-pin accessory jack / micro USB for charging

Packaging and codes

Blister:

2 radios, 2 belt clips,
 2 Ni-MH 700mAh rechargeable battery packs,
 2-way USB cable
code C1464

Case:

2 radios, 2 belt clips, 2 Ni-MH 700mAh rechargeable battery packs, 2-way USB cable, 2 MA21-Li microphones, 2 neck collars.

code C1464.01

* In optimal environmental and atmospheric conditions

101 CHANNELS 24 PMR446-69 LPD	142 CTCSS+DCS TONES	 WATERPROOF IPX4	 DISPLAY NIGHT	 VOX 9 LEVELS	 SIDE TONE
 CALL 5 TONES	 HIGH/LOW POWER	 VIBRACALL	 SCAN	 RETE RADIO MONTANA	 BATTERY PACK BATTERY LIFE 12H
 USB CHARGE	 2-PIN				

XT30 PRO

6 km* range.

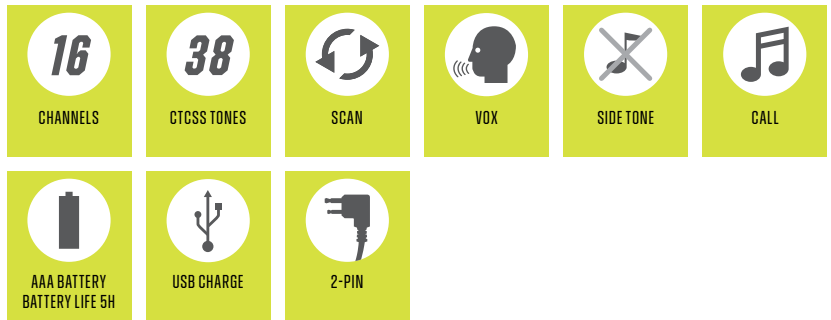

XT30 Pro keeps the green colour to give continuity, but definitely expands its performance with a wider frequency band and resistance to humidity and dew (splash proof).

Version: PMR446
Colour: Black/Metallic green
Channels: 16
Tones: 38 CTCSS

Features

- Rechargeable via USB
- High-performance loudspeaker
- Splash proof
- Side tone: end of transmission tone silencer
- Auto power save, Low battery indicator
- VOX, CALL, SCAN, keypad lock
- Power supply: 3 rechargeable AAA batteries (up to 5 hours' autonomy)
- 2-pin accessory jack/USB for charging

Packaging and codes

Blister with 2 radios, 2 belt clips, 6 AAA rechargeable batteries, 2-way USB cable.
code C1463

XT10 PRO

4 km* range.

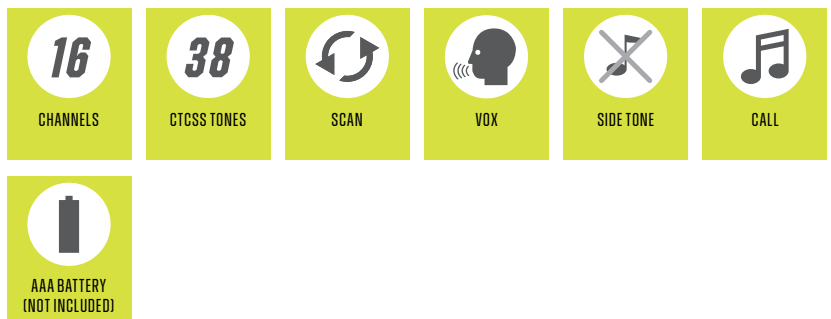

The new version of this model introduces appreciable technical improvements, including the extended PMR446 band and resistance to humidity and dew (Splash proof).

Version: PMR446
Colour: Black/Red
Channels: 16
Tones: 38 CTCSS

Features

- High-performance loudspeaker
- Splash proof
- Side tone: end of transmission tone silencer
- Auto power save: automatic battery saving
- Low battery indicator
- VOX, CALL, SCAN, keypad lock
- Power supply: 3 AAA batteries (up to 20 hours' autonomy)

Packaging and codes

Blister with 2 radios, 2 belt clips.
code C1459



NEW



XT10 PRO MULTICOLOR PACK

The brightly coloured XT10 Colour series – endless fun for all the family. Up to 4 km*.

Thanks to its wider frequency band (PMR446: 446.00625 – 446.19375 MHz), the XT10 Pro delivers reliable performances in any condition, as well as being moisture- and dew-resistant (splash proof). It guarantees efficient communications over distances of up to 4 km in optimal conditions, delivering the same easy-to-use features as the XT line and retaining all the previously existing functions. These simple and

lightweight devices are extremely practical and help improve safety during outdoor activities.

Packaging and codes

3 transceivers with belt clip.
code C1459.02

* In optimal environmental and atmospheric conditions



reddot winner 2022

**THE XT PRO LINE
HAS BEEN AWARDED
IN THE PRODUCT
DESIGN CATEGORY.**

The RedDot Award, one of the most prestigious design awards worldwide, saw us among the winners of the 2022 edition, in the Product Design section.

The judgement, entrusted to a pool of experts gathered in a panel, came after the analysis of over 6,500 products during the year, coming from many companies and sectors.

From gardening to competitive sports, from automotive to the planning of houses and kits, each application is analysed with precision and attention.

What distinguishes the award - in addition to its long tradition - is the complementarity between design and quality: the tests, in fact, are focused on the overall evaluation of the product, combining aesthetic as well as performance pluses.

A result that once again confirms our daily dedication to making communication accessible to all, and which makes us even more proactive in our goals.

XT70 PRO will be officially listed in the Red Dot Design Museum in Essen, Germany.

XT5

The walkie talkie for families.



XT5 is the new and colourful pocket 'miniature' radio for the whole family. Use real channels, scan all frequencies in a 4km range, use half-duplex transmission and make the adventure even more thrilling!

Designed to have fun with the whole family and of course with friends, the new XT5 walkie talkie is compact, available in bright colours and almost stylized in shape.

Easy to use and intuitive, the walkie talkie in question is equipped with a screen, which displays the channel you are using or the battery level, and a group of 5 buttons with the PTT button in the centre, which is easily recognizable and opens communication with other radios.

XT5 also allows customizing some functions, such as the activation of the Roger Beep as an alert at the end of the call or to silence the tone at the end of the transmissions.

Fun to use, in the open air the XT5 walkie talkie becomes indispensable for every little explorer, attached to the belt via the practical clip.

Version: PMR446
Colour: Blue/Yellow/Red/Green
Channels: 8
Tones: 38 CTCSS

Features

- Roger Beep
- Range: up to 4 km*
- Belt clip
- VOX on 3 levels
- SCAN function
- 38 CTCSS tones
- Monitor
- Channels scan
- Battery level indicator
- Transmission end tone silencer
- Call function

Packaging and codes

Blister with 4 radios in different colours and belt clips.
C1425.01



8 CHANNELS	38 CTCSS TONES	SCAN	VOX 3 LEVELS	SIDE TONE	CALL
AAA BATTERY (NOT INCLUDED)					

XT70 / XT70 ADVENTURE

12 Km range*, with earphones, volume knob and quick desktop charger.



XT70

XT70 Adventure



Version: PMR446/LPD
Colour: Blister Black /Metallic dark grey
 Case Black /Yellow
Channels: 8 + 16 pre-set PMR446 - 69 LPD
Tones: 38 CTCSS + 83 DCS

Features

- Rechargeable via USB
- Side tone: end transmission tone muffler
- Out of range, Baby-Sitting function, Keypad lock
- Auto power save: automatic battery saving
- Low battery indicator
- VOX with 9 levels of sensitivity
- CALL with 5 selectable tones
- SCAN
- High/low power selection
- Fast charger (4 hours)
- Power supply: Rechargeable battery pack (up to 18 hours battery life)
- 2-pin accessory jack/USB for charging

Packaging and codes

Blister: 2 radios, 2 professional belt clips, 1 double desktop charger, 2 rechargeable battery packs, USB cable, 2 earpiece microphones MA21-Li.

code C1180

Case: 2 radios, 2 professional belt clips, 2 single desktop fast chargers, 2 rechargeable battery packs, 2 wall adapters, 2 USB cables, earpiece microphones MA21-Li.

code C1180.01

XT60

10 Km range*, with volume knob and quick desktop charger.



Version: PMR446/LPD
Colour: Black /Metallic light blue
Channels: 8 + 16 pre-set PMR446 - 69 LPD
Tones: 38 CTCSS + 83 DCS

Features

- Rechargeable via USB
- Side tone: end transmission tone muffler
- Auto power save: automatic battery saving
- Low battery indicator
- VOX with 9 levels of sensitivity
- CALL with 5 selectable tones
- SCAN, Keypad lock
- High/low power selection, Fast charger (3 hours)
- Power supply: Rechargeable battery pack (up to 12 hours battery life)
- 2-pin accessory jack/USB for charging

Packaging and codes

Blister with 2 radios, 2 belt clips, 1 double desktop charger, 2 rechargeable battery packs, USB cable.

code C1179

TALKER XT SERIES

XT50 / XT50 ADVENTURE

8 Km range*, with desktop charger.



XT50

XT50 Adventure



Version: PMR446
Colour: Blister Black /Metallic grey
 Case Black /White
Channels: 8 + 16 pre-set
Tones: 38 CTCSS

Features

- Rechargeable via USB
- Side tone: end transmission tone muffler
- Keypad lock
- Auto power save: automatic battery saving
- Low battery indicator
- VOX with 3 levels of sensitivity
- CALL, SCAN
- Power supply: Rechargeable battery pack (up to 12 hours battery life)
- 2-pin accessory jack/USB for charging

Packaging and codes

Blister: 2 radios, 2 belt clips, 1 double desktop charger, 2 rechargeable battery packs, USB cable.
code C1178

Case: 2 radios, 2 belt clips, 1 double desktop charger, 2 rechargeable battery packs, USB cable, 1 wall adapter, 2 earphones MA21Li.
code C1178.03

XT30

6 Km range*.

Version: PMR446
Colour: Black /Metallic green
Channels: 8 + 8 pre-set
Tones: 38 CTCSS

Features

- Rechargeable via USB
- Side tone: end transmission tone muffler
- Auto power save: automatic battery saving
- Low battery indicator
- Keypad lock, VOX, CALL, SCAN
- Power supply: 3 rechargeable AAA batteries (up to 5 hours battery life)
- 2-pin accessory jack/USB for charging

Packaging and codes

Blister with 2 radios, 2 belt clips, 6 AAA rechargeable batteries, 2 way USB cable.
code C1177



XT10

4 Km range*.

Version: PMR446
Colour: Black /red
Channels: 8 + 8 pre-set
Tones: 38 CTCSS

Features

- Side tone: end transmission tone muffler
- Auto power save: automatic battery saving
- Low battery indicator
- Keypad lock, VOX, CALL, SCAN
- Power supply: 3 AAA batteries

Packaging and codes

Blister with 2 radios, 2 belt clips.
code C1176



*in optimal conditions

GB1-R

The PMR446 that looks like a CB.



99 CHANNELS 8+16 PREPROG	155 CTCSS+DCS TONES	 SCAN	 SIDE TONE	 TOT*	 FLIP DISPLAY
---------------------------------------	----------------------------------	----------	---------------	----------	------------------

**PLEASE CHECK YOUR COUNTRY
USE RESTRICTIONS**

GB1-R guarantees wide-ranging communications and radio contact with other users equipped with PMR446 equipment. Superb solution for those who **travel by car or caravan**, above all due to the fact that, operating on PMR446 frequencies, it is not affected by disturbances generated by the engine of your vehicle. **GB1-R**, thanks to its very small size, integrated magnetic antenna and the supplied 12V cigarette lighter plug, can be installed and removed quickly without having to be fixed in the special compartment of the dashboard. The metal chassis makes it very robust to ensure excellent performance over the years.

Version: PMR446

Colour: Black

Channels: 8 + 91 pre-set

Tones: 50 CTCSS + 104 DCS

Features

- Microprocessor-controlled frequency
- 'Flip' function: the transceiver can be fitted with the speaker aimed downwards or vice-versa, the display is inverted by pressing a button
- Adjustable squelch on 9 levels
- SCAN function and Monitor
- LCD display
- Integrated magnetic antenna
- TOT (Time out timer)*
- Side tone: noise blanker at end of transmission
- Busy channel (BCLO-Busy Channel Lockout)*
- Broad/narrow band selection 25 kHz/12.5 kHz (only export version)*
- High/low power (only export version)*

Packaging and codes

Radio, microphone, microphone holder, integrated wired magnetic antenna, mounting bracket, fixing screws, supply cable with car charger.

code C1198.02

Export version 5W

* Software programmable only Extra UE countries

Programming software

PRG-GB1 C1227

Complete with USB cable to connect to a PC

THE REAL RADIO AMATEURS.

They are people who, both out of passion and out of curiosity, entered the wonderful world of radio and were able to appreciate the joy that you feel when communicating thousands of kilometres away.

From a regulatory point of view, the radio amateur is a person authorized to transmit, that is, who has obtained the so-called license and general authorization.

How to achieve this?

First of all, it is necessary to acquire a minimum of knowledge of radio technology and the use of all the frequencies assigned internationally to the Amateur Service.

The figure of the radio amateur still plays a very important role in the event of a disaster by making available its tools and ability to ensure links between the various bodies in order to disseminate news and coordinate relief efforts.

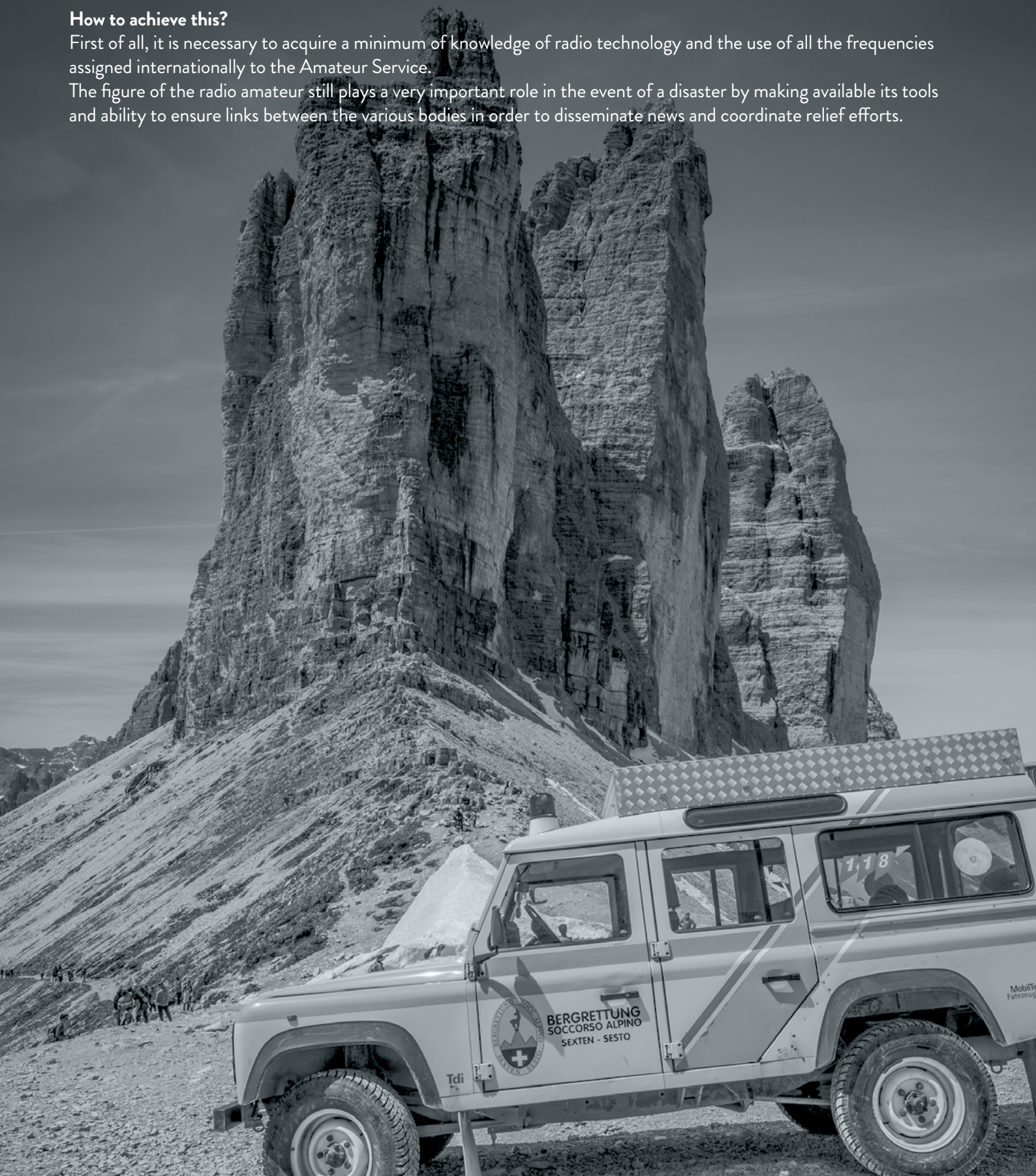

CT990-EB (EXTRA BATTERY)

The most powerful VHF/UHF, autonomy up to 21h.



CT990-EB, IP67 certified for use even in extreme conditions, has two supplied antennas that allow you to choose based on the type of use and requirements. Thanks to its **10W**, this radio has a good potential to hook up a repeater bridge, and for example reach distances of a few tens of kilometres, even 50 Km. The CT990-EB is equipped with the **Dead Man** or Man Down function, very useful when you are alone or isolated. This function constantly monitors the status of the person wearing the radio and detects a fall to the ground due to illness or injury. CT990-EB is the reliable radio you can always take with you.

Version: Dual Band VHF/UHF
Colour: Black
Frequency: 144-146 MHz
 (Export 136-174 MHz)
 430-440 MHz
 (Export 400-470 MHz)
Output power: 10W VHF/UHF

Features

- 257 memory channels
- 83 + 83 DCS codes and 38 CTCSS tones
- Selectable channel spacing 25/12.5 kHz
- Dual band VHF/UHF displayed
- Frequency band (settable according to country/area of use): 144-146 MHz & 430-440 MHz (Rx/Tx).
- Operating mode: UHF/VHF, VHF/VHF or UHF/UHF
- Selectable channel step 25/12.5 kHz
- IP67 certificate
- Dead Man function
- DQT function (private conversation)
- Wide colour LCD display
- Activation tones for repeater bridges
- Individual/group selective calls
- VOX, Side Tone, Roger Beep functions
- Voice indication of the selected "VOICE" function
- Optional display of the channel number, channel number and frequency, channel name
- Inverted frequency function
- Scan function/FM radio receiver
- Selectable transmission power: 10/5W
- Frequency offset, Shift repeater
- "Busy channel lock" function
- Output power level indicator on the display
- TOT (Time Out Timer), Keypad lock
- Reset of functions/channels
- Low battery voice announcement
- Li-Ion 3600mAh battery pack
- Accessory socket: 2-pin Kenwood

Packaging and codes

Radio, **long and short antennas**, Li-Ion 3600mAh battery pack, belt clip, desktop charger, wrist strap, wall adapter.

code C1339.01

■ Supplied with 2 antennas

Long antenna: enhances the radio performance in TX/RX

Short antenna: allows better handling

Programming software

PRG10 C974.01

Complete with USB connection cable for PC

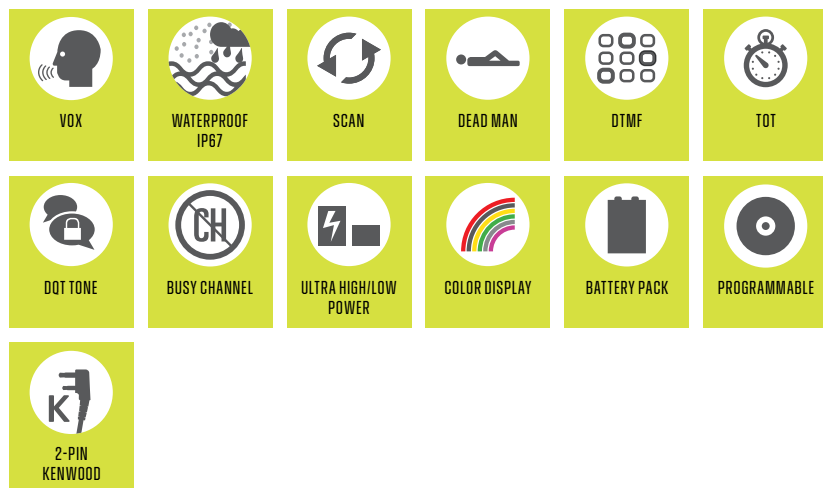

CT590 S

The entry level dual bander.



Version: VHF/UHF
Colour: Black
 Mimetic Mossy Oak orange
Frequency: 144-146 MHz
 (Exp. 136-174 MHz)
 430-440 MHz
 (Exp. 400-480 MHz)
Output power: 5W VHF/UHF

Features

- 50 CTCSS tones and 208 DCS codes
- 128 channels can be stored
- 1750Hz tone for repeater bridges
- Emergency SOS function
- Channel and dual band VHF/UHF displayed
- Operation mode:
 UHF/VHF, UHF/UHF, VHF/VHF
- Output power: 5W UHF/VHF
- 3-colour LCD display with selectable backlight
- FM radio receiver (87.5-108 MHz)
- Scan, Dual Watch
- Channel Spacing: 25 kHz / 12.5 kHz
- VOX adjustable on 10 levels
- Channel or frequency mode selection
- TOT (Time Out Timer)
- DTMF Function
- Reverse function
- Emergency alarm function
- Setting up and storing channel names
- CTCSS and DCS code search function
- PTT-ID
- BCLO (Busy Channel Lockout function)
- High/low power selection
- Frequency step: 2.5/5/6.25/10/12.5/25 kHz
- Adjustable Frequency Offsets: 0-69.990 MHz
- Adjustable Offset Direction
- Squelch adjustable on 9 levels
- Voice announcement of the selected function
- Keypad lock
- Power Save (battery economy)
- Programmable from PC
- Li-Ion 1500 mAh battery pack
- 2-pin Kenwood accessory socket

 VOX	 SCAN	 CTCSS/DCS SCAN	 EMERGENCY	 DTMF	 TOT
 BUSY CHANNEL	 HIGH/LOW POWER	 FM RADIO	 VOICE ANNOUNCEMENT	 DISPLAY 3 COLOURS	 BATTERY PACK
 PROGRAMMABLE	 2-PIN KENWOOD				

Packaging and codes

Radio, 1500 mAh 7.4V Li-Ion battery pack, desktop fast charger, wall adapter, antenna, belt clip.

code C1354 Black
code C1354.02 Blaze

Programming software

PRG10 C974.01

Complete with USB connection cable for PC

A man wearing a white hard hat and a blue work jacket with reflective stripes is focused on a laptop. He is standing on the deck of a ship, with the ocean and a sunset or sunrise sky visible in the background. A walkie-talkie is clipped to his belt. The scene is lit with warm, golden light from the sun, creating a professional and industrious atmosphere.

ARCTIC

FOR SAFETY AT SEA.

ARCTIC

The ultimate marine portable VHF radio.



Midland Arctic is an **IP67 certified** VHF marine portable transceiver combining professional technical features with sturdiness and reliability. Its functions are all at hand, including the **button to access emergency channel 16 straight away**. The antenna can be removed and thanks to the standard **SMA connector**, it is possible to use other types of antenna. The management of the Charlie and Alpha channels and functions takes place via optional programming software.

Features

- IP67 waterproof certification
- Aluminium chassis
- Transmission power: 5W
- High/low power selection (5W/1W)
- 57 international channels
- Programmable channels (through software) - also Charlie and Alpha!
- Backlit wide LCD display
- Instant access to the emergency channel 16
- VOX, SCAN function
- Dual Watch/Triple Watch
- 10 different Squelch levels
- Priority channel
- Keypad lock
- Roger Beep (end of call tone) and keypad beep
- Flat battery indicator and automatic battery saver
- Power supply: Li-Ion battery pack
- 2-pin Motorola accessory socket

Packaging and codes

Radio, desktop charger, wall adapter, Li-Ion 1600 mAh rechargeable battery pack, belt clip.
code C1240

Export version: USA/Canada channels



Multi CA PB-G15 Pro C1573

6 position multicharger (optional)

Single desktop charger included in the pack

Programming software PRG-G15 C1131

Complete with USB connection cable for PC

CHANNLES	POWER	WATERPROOF IP67	SCAN	VOX	DUAL WATCH
TRIPLE WATCH	HIGH/LOW POWER	BATTERY PACK	PROGRAMMABLE	2-PIN MOTOROLA	



EARPIECE MICROPHONES - 2-PIN "L" MIDLAND - ONLY PTT



MA21 Secure TX C1543

Microphone with adjustable earpiece and PTT, with curly cord.



MA 25 L C1540.01

High performance speaker microphone, waterproof.



MA 21-Li C709.07

Earpiece microphone.



MA 26 - XL C515.05

Speaker microphone with volume control and earpiece socket.



MA 24 Secure TX C1544

Earpiece microphone with ergonomic and comfortable headset and PTT.



MA 31 Secure TX C1545

Microphone with pneumatic earpiece and PTT.



EARPIECE MICROPHONES - 2-PIN "L" MIDLAND - VOX+PTT



MA 21-L Pro C1496

Microphone with adjustable earpiece and selectable PTT/VOX, with curly cord.



MA 30 - L Pro C1526

Microphone with adjustable arm and selectable PTT/VOX.



MA 24-L Pro C1525

Speak/listen microphone with selectable PTT/VOX.



MA31 L Pro C1497

Microphone with pneumatic earpiece and selectable PTT.



MA 28 - L C559.03

Speak/listen microphone with selectable PTT/VOX.

NB: MA28-G5 except Alan421-G5XT.



MA 35 - L C652.02

Headphone with microphone.



EARPIECE MICROPHONES - 2-PIN "L" MOTOROLA



MA 24-M C1610

Earpiece microphone with ergonomic and comfortable headset and VOX/PTT, compatible with **G15/G18 line**.



MA 27-M C1130

Microphone with PTT, compatible with **Midland G15/G18 line**.



MA 25-M C1129

Waterproof speaker microphone, compatible with **Midland G15/G18 line**.



MA 31-M C732.06

Microphone with pneumatic earpiece, compatible with **Midland G15/G18 line**.



EARPIECE MICROPHONES - 2-PIN "L" KENWOOD



BA21 C1298

HIGH PERFORMANCE

Adjustable earpiece microphone and PTT.
Ergonomic and comfortable, extremely robust cable for professional use.



MA 21-XK C709.06

Microphone with adjustable earpiece and PTT.



BA24 C1296

HIGH PERFORMANCE

Headset microphone.
Ergonomic and comfortable, extremely robust cable for professional use.



MA 21-LKi C1306

Microphone with adjustable earpiece and PTT, curly cord, competitive price.



BA31 C1299

HIGH PERFORMANCE

Microphone with pneumatic headset and PTT. Discreet and flexible, high quality transparent hose. Cable for professional use.



MA22-LK Pro C1542

Speaker microphone.
Only PTT.



MA21-LK Pro C1496.01

Microphone earphone.



MA 24-LK C1611

Earpiece microphone with ergonomic and comfortable headset and PTT



LISTENING ONLY

MA21-KE C1495

Microphone with pneumatic headset.



MA25 LK C1540

Speaker microphone waterproof.



Walkie-Talkie

G18 Pro/G15 Pro
G13/ G11 Pro/G10 Pro
777 Pro
G9 Pro/G7 Pro/XT70-50-30 Pro/XT 70-60-50-30

2-Pin Motorola
2-Pin Kenwood
1-Pin
2-Pin

VHF/UHF

CT990-EB/CT590 S
Arctic
CB
Alan 42 DS

2-Pin Kenwood
2-Pin Motorola
2-Pin

EARPIECE MICROPHONES - 1-PIN



MA21-777 Pro C1437

Microphone earphone with PTT, 1-pin 3.5 mm (777 Pro).



MA 24-777 Pro C1598

Earpiece microphone with ergonomic and comfortable headset, only PTT. 1 pin 3.5mm (777 Pro).



**LISTENING ONLY
TOURISTIC USE
(SINGLE USE)**

C1243

Iphone style earphone, mono, 3.5 mm
Listening only.



MA 21-SX C709.02

Microphone with adjustable earpiece and selectable PTT/VOX, with 2.5-mm curly cord (Midland 777).



MA31-777 Pro C1438

Microphone with pneumatic earpiece and PTT, 1-pin 3.5 mm (777 Pro).



**LISTENING ONLY
TOURISTIC USE
(SINGLE USE)**

C1282

Iphone style earphone, jack silver 3.5 mm - cable length 115 cm.



EARPIECE ACCESSORIES FOR SOFTGUNNERS



Military headset

To listen without being heard

Military headset with detachable boom microphone (**it can be worn on the right or on the left**), tactical PTT and dual sound system (traditional speaker or air tube earpiece).

Bow-M Evo C1046.02

2-Pin Midland socket

Bow-M Evo K C1046.03

2-Pin Kenwood socket



Speaker

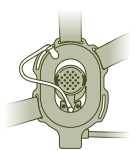

Pneumatic headset

PTT+Clip

PTT+Midland Clip for Bow-M C1088

2-Pin Midland socket

PTT+Kenwood Clip for Bow-M C1088.01

2-Pin Kenwood socket



Earpiece

EP21 C859

Earpiece 3.5mm jack socket (not compatible with Midland 777).
Listening only



Microphones with PTT

ABM Tactical C855.01

Earpiece microphone with adjustable arm and tactical PTT. 2-Pin Midland socket.



A21M C858

Earpiece microphone with standard PTT. 2-Pin Midland socket.



WALKIE TALKIE ACCESSORIES

Chargers



- **R73713**
Double desktop charger
Attention: to be used only with R73168 wall charger.

G7 Pro

- **R73579**
Double desktop charger.

Midland 777, Onda

Cigarette lighter

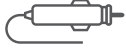

- **AL777 C803**
Cigarette lighter power lead.

777, G5 R1, G12,
Pacific

Wall chargers



- **MW904 C689**
Wall charger.

G9 Pro, G9
G9 Plus, G7 Pro
G7XT, G6XT G5XT,
G8, M24, MA48,
MA99

- **MW905 C887**
Wall charger.

Midland 777, Onda,
G12, G5 R1, Pacific

- **R71968**
Wall charger with double jack.

Midland 777
Onda

Batteries



- **C1433**
AA rechargeable battery 1800mAh (4 AA).

G9 Pro
G7 Pro

- **PB-70 Pro C1523**
700mAh Ni-Mh rechargeable battery pack.

XT70 Pro,
G7/G9 line

- **Battery Kit 4 Pcs R02246**
650mAh Lithium rechargeable battery

Midland 777
Onda

- **PB-777 Pro R01956**
1000mAh Lithium rechargeable battery pack.

777 Pro

- **PB-G10 C1126**
1200mAh Lithium rechargeable battery.

G10

- **PB-G10 Pro C1454**
2600mAh Lithium rechargeable battery.

G10 Pro
G13

- **PB-G15/18 C1128**
1600mAh Li-Ion rechargeable battery.

G15, G18 line

- **PB-G11 C967**
1600mAh Lithium rechargeable battery.

G11 line

- **PB-ATL/G7 C784**
800mAh Ni-MH rechargeable battery.

G7 line, G9,
Pacific

- **PB-Pro C1148**
1200mAh Lithium rechargeable battery.

G7 Pro
G9 Pro

- **PB-X6 C1300**
700mAh rechargeable battery pack.

XT60, XT50 Pro,
XT50

- **PB-X7 C1301**
1000mAh rechargeable battery pack.

XT 70

- **PB-BR03 R01916**
2300mAh Li-Ion rechargeable battery pack.

BR03

- **PB200/400 C846**
1200mA Li-Ion rechargeable battery pack.

G14, CT 200/400
CT 210/410

MULTICHARGERS

Multichargers

- **Multi CA-G13 C1541.01**
4 position multicharger.
Compatible with **G13, G10 Pro**



- **Multi CA PB-BR03 C1353**
6+6 position multicharger.
Compatible with **BR03**



- **Multi CA PB-G15 Pro C1573**
6 position multicharger.
Compatible with **G15 G18 line, Arctic**



- **Multi CA PB-BR02 C1295**
6 position multicharger.
Compatible with **BR02**



CASE - BATTERY ELIMINATOR

G9 Pro/G7 Pro case

- **Neoprene case C1613**
Synthetic leather case designed to protect your Midland radio.
- **Leather case C1577**
Lether case designed to protect your Midland radio.



Battery eliminator G18/G15/Arctic

- **C1406**
Battery eliminator with power supply cable (cigarette lighter plug) for **G15/G18 line and Arctic**.



VHF/UHF ACCESSORIES

Chargers - USB cable



- | | |
|---|---------------|
| ● C1456 | CT990 |
| CT990 charger. | |
| ● R73642 | CT 510 |
| Desktop battery charger (to be used with the R73644 USB cable). | |
| ● R74116 | CT890 |
| Quick desktop charger with wall adapter. | |
| ● R73644 | CT 510 |
| USB cable. | |



Batteries



- | | |
|---------------------------------------|--|
| ● R02915 | CT 990 |
| 3600 Mhz Li-Ion rechargeable battery. | |
| ● PB200/400 C846 | CT 200/400
CT 210/410/710 |
| 1200 mAh Li-Ion rechargeable battery. | |

CT510 earpiece microphone

- **R73725**
Earpiece microphone.



See other earpieces/microphones with 2-pin Kenwood accessory socket, page 35.

WALKIE TALKIE ANTENNAS

G7 Flex C646.01

Flex antenna with adapter. Length: 35cm.
For Midland **G7 line, G8, G9, G14, G11, G15, G18.**



R73197

Long antenna. Length:
16 cm. For Midland **G11, G14, G15, G18.**



R72770

Short antenna. Length:
9 cm. For Midland **G11, G14, G15, G18.**



VHF/UHF ANTENNAS



ANT710 R01940

For **CT510 CT710 CT890**



R74455

For **CT690 CT590 CT790 CT200 CT400**



RH-771 C637

Flex



SRH-536 C646

Super Flex-SMA

Features	ANT710	R74455	RH-771	SRH-536
Frequency	TX: 144/430 MHz	TX: 144/430 MHz	TX: 144/430 MHz	TX: 144/430 MHz
Type	1/4λ(144 MHz) 1/2λ(430 MHz)	1/4λ- (144 MHz) 1/2λ- (430 MHz)	1/4λ(144 MHz) 1/2λ(430 MHz)	1/4λ- (144 MHz) 1/2λ- (430 MHz)
Band	136/174 MHz 400/470 MHz	136/174 MHz 400/470 MHz	120-150/300-450 MHz 800-900 MHz only in RX	300/800 MHz 900 MHz only in RX
Length (cm)	13	13	40	37
Connector type	SMA male	SMA female	BNC	SMA

USB CHARGERS

MP-DIN USB-C

Car lighter C1565

12/24V double charger with DIN, USB and USB-C DIN socket (BMW).



MP-W Adapter C1197

12V cigarette lighter/
Din adapter (BMW).



MP-H 2 USB Pro C1494

Dual USB socket motorcycle
charger. Handlebar or built-in
installation.



MP-DIN USB-C C1514

12/24V charger with
USB+USB-C DIN socket
(BMW).



BUSINESS RADIO OVERVIEW TABLES

Model	G18 Pro	G15 Pro	G13	G11 Pro
Band	PMR446	PMR446	PMR446	PMR446
Channels	16+83 pre-set	16+16 pre-set	16+83 pre-set	16+16 pre-set
CTCSS and DCS	50 CTCSS, 105 DCS	50 CTCSS, 105 DCS	50 CTCSS 106 "N+106 "I" DCS	50 CTCSS, 105 DCS
Vox	9 sensitivity levels	9 sensitivity levels	9 sensitivity levels	9 sensitivity levels
Power supply	1600mAh Li-Ion rechargeable battery pack	1600mAh Li-Ion rechargeable battery pack	2600mAh Li-Ion rechargeable battery pack	1600mAh Li-Ion rechargeable battery pack
Autonomy 5/5/90	22h	22h	40h	22h
Display	Multifunction back-lit LCD	-	Multifunction back-lit LCD	-
Transmission power	500mW ERP (high/low level)	500mW ERP	500mW ERP	500mW ERP
Operating temperature	-20° +55°C	-20° +55°C	-20° +55°C	-20° +55°C
Weight (without batteries)	146 g	138 g	129 g	123 g
Size (WxHxD)	113x56x38 mm	100x58x33 mm	117x60x42 mm	112x58x34 mm
Connections	Socket for audio accessories	Socket for audio accessories	Socket for audio accessories	Socket for audio accessories
Accessory socket type	2-pin Motorola	2-pin Motorola	2-pin Kenwood	2-pin Kenwood
Compatible wall charger	desktop charger only	desktop charger only	desktop charger only	desktop charger only

Model	G10 Pro	777 Pro	G9 Pro
Band	PMR446	PMR446-LPD (Dual-band)	PMR446-LPD (Dual-band)
Channels	16+16 pre-set	PMR446: 16 LPD: 69	PMR446: 16+16 progr. LPD: 69
CTCSS and DCS	50 CTCSS 116 "N+116 "I" DCS	38 CTCSS/104 DCS	38 CTCSS, 104 DCS
Vox	-	9 sensitivity levels	3 sensitivity levels + talk back
Power supply	1200mAh Li-Ion rechargeable battery pack	1000mAh Li-Ion rechargeable battery pack	4 AA 1800mAh rechargeable batteries or 4 AA alkaline batteries (opt)
Autonomy 5/5/90	16h	Up to 14 h	23h with 4 1800mAh batteries
Display	-	Liquid crystal EEDTM	Multifunction back-lit LCD
Transmission power	500mW ERP	500 mW ERP	PMR446 500/10mW ERP (high/low) LPD 10mW
Operating temperature	-20° +55°C	-20° +55°C	-20° +55°C
Weight (without batteries)	118 g	65 g	114 g
Size (WxHxD)	118x60x35 mm	44x85x27	68x120x35mm
Connections	Socket for audio accessories	Socket for audio accessories	Socket for audio accessories, charger
Accessory socket type	2-pin Kenwood	3.5mm (4 contacts)	2-pin
Compatible wall charger	Desktop charger only	Desktop charger only	MW904

WALKIE TALKIE OVERVIEW TABLES

Model	G7 Pro	XT70 Pro	XT50 Pro
Band	PMR446-LPD (Dual-band)	PMR446-LPD (Dual-band)	PMR446-LPD (Dual-band)
Channels	PMR446: 16 LPD: 69	PMR446: 16 + 16 preprogr. LPD: 69 LPD	PMR446: 16 LPD: 69 LPD
CTCSS and DCS	38 CTCSS/104 DCS	38 CTCSS/104 DCS	38 CTCSS/83 DCS
Vox	6 sensitivity levels	9 sensitivity levels	3 sensitivity levels
Power supply	800mAh/1200mAh Li-Ion (opt) battery pack or 4 AA rechargeable batteries	700mAh battery pack (PB-70Pro)	3 AAA rechargeable batteries or 700mAh battery pack (PB-X6)
Autonomy 5/5/90	Up to 18h with 800mAh battery pack	Up to 17h	Up to 12h
Display	Multifunction back-lit LCD	Multifunction back-lit LCD	Multifunction back-lit LCD
Transmission power	PMR446 500/10mW ERP (high/low) LPD 10mW	500 mW ERP	500 mW ERP
Operating temperature	-20° +55°C	-20° +55°C	-20° +55°C
Weight (without batteries)	123 g	123 g	94 g
Size (WxHxD)	58x122x34 mm	58x120x33 mm	49x102x30 mm
Connections	Socket for audio accessories, charger	Socket for audio accessories	Socket for audio accessories, USB
Accessory socket type	2-pin	2-pin	2-pin
Compatible wall charger	MW904	C1254	R73487

Model	XT30 Pro - XT10 Pro	XT5	GB1-R
Band	PMR446	PMR446	PMR446
Channels	16	8	8+91 pre-set
CTCSS and DCS	38 CTCSS	38 CTCSS	50 CTCSS, 104 DCS
Vox	1 sensitivity level	3 sensitivity levels	-
Power supply	3 AAA rechargeable batteries	4 AAA batteries	12Vdc +/-10%
Autonomy 5/5/90	Up to 5h (XT30 Pro)	Up to 20h (with alkaline batteries)	-
Display	Multifunction back-lit LCD	-	Multifunction back-lit LCD
Transmission power	500 mW ERP	500 mW ERP	≤ 500mW ERP
Operating temperature	-20° +55°C	-20° +55°C	-20° +55°C
Weight (without batteries)	XT10 Pro: 75 g; XT30 Pro: 83 g	69 g (without battery)	220 g
Size (WxHxD)	48x90x29 mm	49x128x30 mm	100x85x22 mm
Connections	Socket for audio accessories, USB (XT30 Pro only)	-	Socket for external speaker
Accessory socket type	2-pin (XT30 Pro only)	-	3.5 mm mono
Compatible wall charger	R73487	-	-

VHF/UHF RADIO OVERVIEW TABLES

Model	CT990 EB	CT590S
Frequency	144-146 MHz 430-440 MHz	144-146 MHz 430-440 MHz
Operating temperature	-20° -+55°	-20° -+55°
Voltage supply	7.4V	7.4V
Operating mode	Simplex or Semi-duplex	Simplex or Semi-duplex
Size (whitout antenna)	140x60x35mm	115x58x35.5mm
Weight (battery included)	310 g	230 g
Antenna impedance	50Ω	50Ω
Use cycle	5/5/90	5/5/90
Transmitter		
Frequency stability	±2.5PPM	±2.5PPM
Output power	10W (UHF/VHF)	VHF: 5W UHF:5W
Max. frequency deviation	5 kHz	5 kHz
Audio distortion	≤ 3%	≤ 3%
Receiver		
RF sensitivity	< 0.2μV	< 0.2μV
Audio distortion	≤ 3%	≤ 3%
Audio response	300Hz ÷ 3 kHz	300Hz ÷ 3 kHz

VHF MARINE RADIO OVERVIEW TABLE

Model	Arctic
Channels	57 international
TX frequency coverage	156.025 to 157.425 MHz
RX frequency coverage	from 156.300 to 162.000 MHz
Operating temperature	from -15°C to +55°C
Size (WxHxD)	115 x 55 x 37mm
Weight (transceiver only)	230 g
Accessory socket type	Motorola 2.5 mm/3.5 mm
Programmable	Via software (PRG-G15)
Water protection grade	IP67
Transmitter	
Output power	Selectable 1W or 5W
Frequency stability	±2.5PPM
Audio distortion	≤ 3%
Receiver	
Sensitivity 20dB Sinad	0.3 μV
Audio output power	300mW @ 10% THD
Audio distortion	< 10%

CB RADIOS



MIDLAND®

THE BEST SUITED CB RADIO FOR YOUR NEEDS.

Are you a truck driver? Do you have a caravan or an off-road vehicle? Do you want to use the so-called “citizen band” to communicate with others?

Below you will find a small guide for your needs. In the following pages, you will find every detail and technical information regarding each model.

YOUR FIRST CB RADIO



Are you looking for a CB radio that's easy to install and use?

CB Go USB

M Zero Plus

Alan 100 Plus B

THE ROAD IS YOUR CRAFT



Are you a truck driver looking for perfect modulation?

CB Handsfree Kit

Alan Quarantotto

Alan 48 Pro/Alan 78 Pro

Midland 88



Are you a farmer or a tractor driver?

CB Handsfree Kit

Alan Sessantotto

M-5

Midland 88

CB: contribution of €12 and declaration of activity have been abolished

The decree issued on 17/7/2020 which sanctions the liberalization of the CB band (40 channels) has finally become law.

Thanks to Law No. 120 of 11 September 2020, it is now no longer necessary to fill in and submit the self-certification to the Italian Ispettorato Territoriale and pay an annual contribution of €12.

Discover the video



TRAVELLING IS YOUR PASSION



**Travelling by caravan?
Choose among the most reliable CBs.**

Kit CB Camper

Alan 42 DS

M-Mini USB

Dual Mike Wireless

Ptt Dual



**Do you want to communicate on your
Off-Road vehicle?**

Kit CB 4x4

Alan 42 DS

M-5

Midland 88

Dual Mike Wireless

I WANT THE BEST!

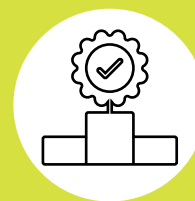

**If you're looking for the most advanced
technology, this is the right CB radio for you.**

Alan Quarantotto

Midland 88

M-30

ALAN 42 DS LITHIUM ALAN 42 DS

The best-selling portable CB.



The autonomy doubles and recharging is 10 times faster. **Alan 42 DS** is the portable CB transceiver par excellence featuring fully updated electronics to give a unique audio experience. Now also available in a version with Lithium battery.

It is fitted with **digital squelch, ANL filters and Noise Blanker** that remove all annoying noises caused by sources outside the vehicle.

A multistandard transceiver that allows selecting **any European band and operate in all EU countries.**

Features

- Band: Multi (see page 74)
- Power: 1W/4W depending on the country
- DS: Digital Squelch
- ANL filters/Noise Blanker
- Emergency channel (EMG)
- Keypad lock (LOCK)
- Battery status indicator
- High-lower power (H-L)
- Display back-lighting button
- AM-FM button selection
- SCAN function, Dualwatch
- Antenna socket: BNC
- Powered by 8 AA batteries or 12V
- 2-pin accessory socket

Packaging and codes

Alan 42 DS Lithium Edition

1 radio, Li-Ion 2800mAh 3-cell battery pack (12V), USB-C/USB-C cable for battery pack recharging, empty pack for alkaline batteries, car adapter with socket for external antenna, antenna, belt clip, strap wrist

code C1267.04

Alan 42 DS

1 radio, wall charger for 8 AA battery pack, empty battery pack for 6 AA Alkaline batteries, empty battery pack for 8 AA rechargeable batteries with charging socket, adapter for car use with external SO 239 antenna socket, antenna, belt clip, wrist strap.

code C1267

EXPORT VERSION: 400CH

Optional accessories



PB42 Lithium - C1575

Lithium-ion battery pack, 2800 mAh capacity. Fully charged in maximum 2 hours with USB C-USB C cable (not included).



PB E42 - C602

Empty battery pack to charge 8 AA batteries (not included)



R74593 (Alan 42 DS/Multi)

Car adapter with socket for external antenna SO2399



R17365

Power supply

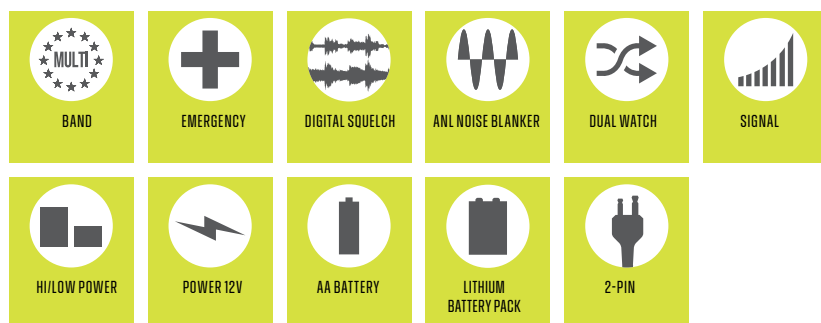

ALAN 42 DS LITHIUM

THE AUTONOMY DOUBLES AND RECHARGING IS 10 TIMES FASTER.



MIDLAND 88

The Din size CB radio.

Discover the video



**THICKNESS:
ONLY 77 MM**

FRONT SPEAKER

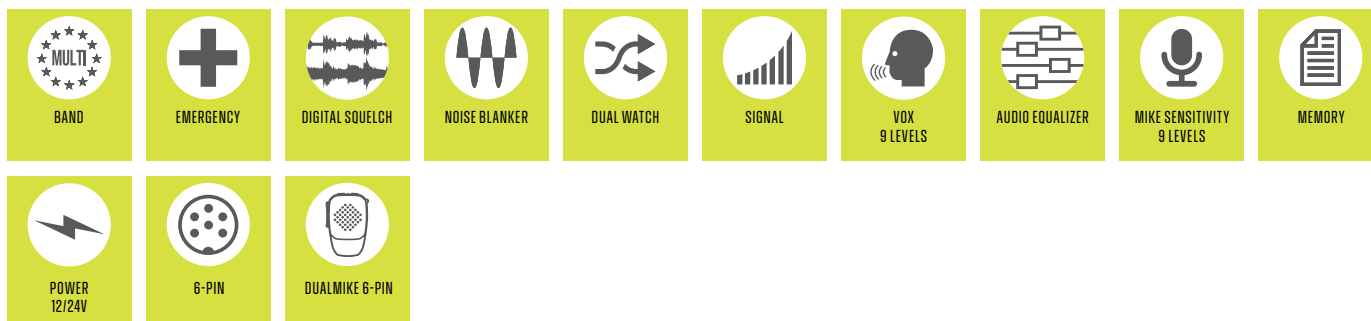

Midland 88 is the most versatile CB radio: compatible with all DIN compartments. It is your inseparable travel companion: on trucks, off-road, in cars and caravans. What other options? You can put it on the dashboard and attach it to the windscreen with the suction cup attachment. Find the right solution for you!

With a large multicolour TFT display, filters to eliminate unwanted noise and a universal power socket (12/24 V), what more do you want from the highly compatible M88?

Features

- Band: Multi (see page 74)
- CB DIN SIZE
- Ultra thin, only 77mm!
- 12/24V power supply
- 3 different supports supplied: fixing bracket, DIN bracket, suction cup mount
- Aluminium chassis

- Wide colour TFT display
- Automatic digital squelch adjustable on several levels
- Emergency channels 9/19
- Noise Blanker and HIC Filters
- Automatic switch-on
- 4 channel memories
- PA function (Public Address)
- Up/Down/Priority channel microphone
- S-Meter
- Dual Watch, Roger Beep
- External loudspeaker socket
- 6-pin microphone connector

Packaging and codes

1 transceiver with power cable, microphone, microphone holder, mounting bracket, Din Size bracket, suction cup mount, fixing screws, protection fuse.

code C1435

Export Version: 400CH 8W AM; 15W FM
Amateur Band: 28/29.695MHz
VFO: 24.715/30.105Mhz





MIDLAND 88

THE THINNEST CB DIN EVER

SUMMER

6.5L TURBO DIESEL

ALAN 48 PRO

The multiband CB for European travel.



The new **Alan 48 Pro** is the top of the range multiband, the CB line expressly conceived for trips and routes in different European countries. What does this mean? It means that **Alan 48 Pro** has an adjustable power – 1W/4W – to be adjusted to the frequencies and regulations of the country in which it is used. With a power supply voltage of 12/24 V, **Alan 48 Pro** does not need reducers and it is of easy installation in the dashboard compartment, thanks to the DIN bracket (optional).

Alan 48 Pro is high tech and complete in facing all sorts of noises: it is equipped with the Digital Squelch, that eliminates the background swish and the Noise Blanker, to cancel the environmental noises.

Features

- Band: Multi (see page 74)
- Output power: 1W/4W depending on the country
- DS: Automatic Digital Squelch
- Noise Blanker/ANL filters
- Power supply voltage: 12/24V
- Blue back-lit multifunction display
- “Precision series” microphone with Up/Down/Lock buttons
- Squelch
- RF Gain: sensitivity control in RX
- MIC Gain: microphone amplification
- 4 memory positions
- Emergency channel
- Scan function

- Dual watch function
- External S-Meter socket
- PA: by enabling this switch, the device becomes a low frequency amplifier (with the help of an additional speaker)
- External speaker socket
- 6-pin microphone connector

Packaging and codes

1 radio, microphone, mounting bracket, fixing screws.

code **C422.16**

EXPORT VERSION: 400CH

ALAN 78 PRO

The compact multiband CB radio.



The new **Alan 78 Pro** is the compact and essential CB radio dedicated to multiband: that is, to the CB frequencies related to travelling and routes in multiple European countries. What does it mean? It means that **Alan 78 Pro** has adjustable power - 1W/4W – that can be adapted to specific frequencies following the laws of the country in which you are travelling. With a 12/24 V power supply, **Alan 78 Pro** does not need reducers and can be easily installed in the dashboard compartment thanks to the DIN bracket (optional). **Alan 78 Pro** is high tech and perfect even when dealing with noise: its Digital Squelch eliminates background noises, while its Noise Blanker eliminates continuous environmental noise.

Features

- Band: Multi (see page 74)
- Output power: 1W/4W depending on the country
- DS: Automatic Digital Squelch
- Noise Blanker/ANL filters
- Power supply voltage: 12/24V
- Blue back-lit multifunction display
- “Precision series” microphone with Up/Down/Lock buttons
- Squelch, Scan
- LCR function (to recall the last channel that was used)
- External speaker socket
- External S-Meter socket
- 6-pin microphone connector

Packaging and codes

1 radio, microphone, mounting bracket, fixing screws.

code **C423.16**

EXPORT VERSION: 400CH

ALAN QUARANTOTTO

The king of CB.

SINCE 1986

The best seller 40Ch CB

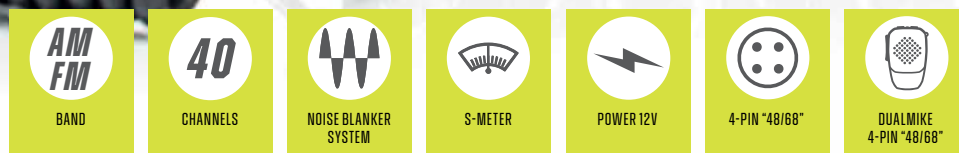

ONLY FOR THE ITALIAN MARKET

The CB that made the communication history, returns completely renewed, but still faithful to the DNA of the historical product. Thanks to its fame, very easy use and its **complete range of functions**, it has been the Italian best-seller for over 30 years. A travelling companion and an **irreplaceable work tool for those who are driving every day**.

Features

- Band: AM-FM
- Noise blanker System
- MIC Gain: Mic gain control for an always perfect modulation
- RF Gain: set the gain of the antenna preamplifier
- FIL: set the intonation of the incoming signal
- ANL: automatic noise cut down
- Squelch
- PA: activating this switch the CB becomes a low frequency amplifier (with additional speaker)
- White LED backlight, for every light condition
- 4-pin microphone connector

Packaging and codes

1 radio, microphone, mounting bracket, fixing screws.

code C217.09

EXPORT VERSION: 10W AM/FM - 120CH

ALAN SESSANTOTTO

The mythical 34-channel CB.

SINCE 1983

The best seller 34 Ch CB



AM
FM

BAND

34

CHANNELS



NOISE BLANKER
SYSTEM



S-METER



POWER 12V



4-PIN "48/68"



DUALMIKE
4-PIN "48/68"

ONLY FOR THE ITALIAN MARKET

The brother of the mythical Alan Quarantotto, that made communication history, returns completely renewed, but still faithful to the DNA of the historical product.

Since 1983 the **sales champion** in its category.

A travelling companion and an **irreplaceable work tool for those who are driving every day**. Particularly appreciated on agricultural vehicles and for earth moving thanks to its reliability and sturdiness.

Features

- Band: AM-FM
- Noise blanker System
- MIC Gain: Mic gain control for an always perfect modulation
- RF Gain: set the gain of the antenna preamplifier
- FIL: set the intonation of the incoming signal
- ANL: automatic noise cut down
- Squelch
- PA: activating this switch the CB becomes a low frequency amplifier (with additional speaker)
- White LED backlight, for every light condition
- 4-pin microphone connector

Packaging and codes

1 radio, microphone, mounting bracket, fixing screws.

code C025.09

EXPORT VERSION: 10W AM/FM - 120CH

M-30

FOR BUSINESS COMMUNICATION

M-30

The multimedia CB.

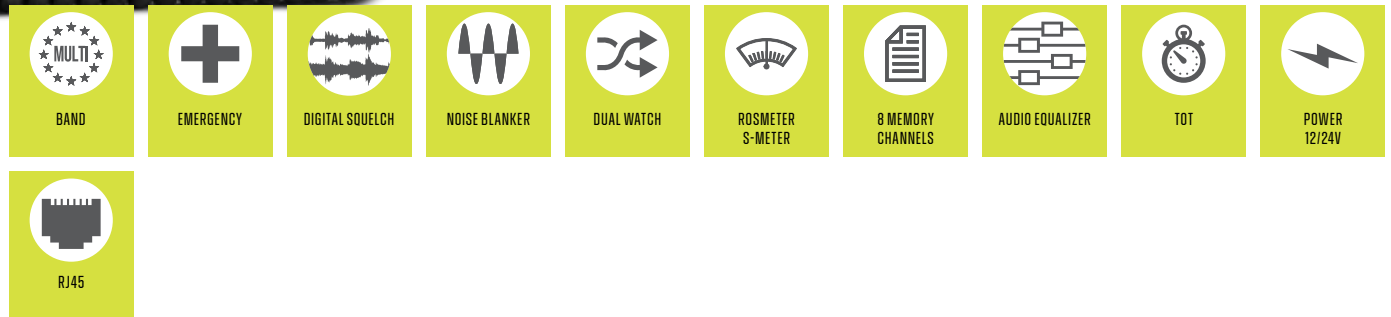

If you are looking for a multi-function CB, this is the model for you. Ready to give you the best of the M series, thanks to **6 programmable keys**, wide **multi-colour TFT display**, with **Dual Watch** function to monitor two channels at the same time. Automatic switch-on, display of the channel number or channel number plus frequency, make it **the perfect tool for communication professionals**.

Features

- Band: AM/FM Multi (see page 36)
- 6 programmable keys
- Wide colour TFT display
- Supply 12V-24V
- Metal alloy radio body for better heat dissipation
- Display of the channel number or channel number + frequency.
- Automatic adjustable Digital Squelch on 9 levels

- S-Meter/SWR Meter
- RF attenuator
- Scan function
- Dual Watch
- Customizable Roger Beep
- 9/19 emergency channels and priority channel
- Noise Blanker
- Audio equalizer
- Protection against polarity inversion
- 8 customizable memory channels
- TOT (Time Out Timer)
- Adjustable backlight
- Automatic switch-on
- Keypad lock
- Microphone with RJ45 connector with keys Up/Down/Priority channel

Packaging and codes

1 radio, microphone, mounting bracket, fixing screws.

code **C1313**

**EXPORT VERSION: AMATEUR BAND
26-28MHZ 400CH 8W (AM)/15W (FM)**

R74574

2 m long microphone extension cord for M-5/M-30/CT3000

**Programming Software PRG-30
C1318**

Complete with USB connection for PC

M-5

The CB “in the mike”.

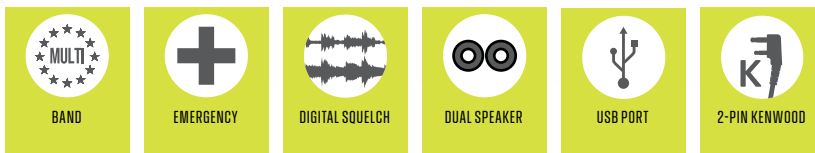

The CB world finds a new style with the **Midland M-5**, the “CB in the mike” to have everything on hand all the time, thanks to the buttons placed directly on the microphone with an LCD display to see channels, bands and settings.

The compact size and its particular configuration allow the radio to be placed in the storage compartment or even in the boot (with accessory cable extension).

A new way to enjoy the CB that allows you to drive with a minimal cabin.

Features

- Band: Multi (see page 36)
- 40 AM/FM channels
- Output power: 4W AM/FM
- Die-cast metal body
- “Handy” controls on the mike
- Selectable multicolour backlight (7 colours)
- Manual squelch 28 levels
- Digital squelch at 5 levels
- RF gain
- Scan
- Indication S-meter RX-TX
- Sliding mounting bracket
- Lighter power supply
- USB socket for charging electrical devices
- 2-pin Kenwood socket (microphone)

Packaging and codes

1 radio, microphone with Up/Down buttons and LCD display, fixing screws, mounting bracket, power cord with cigarette lighter socket.
code C1277

EXPORT VERSION: 10W AM/FM - 400CH

R74574

2 m long microphone extension cord for M-5/M-30/CT3000

Available only at [midlandeurope.com](https://www.midlandeurope.com)

CAMPER CB KIT

M-5 and glass antenna make the perfect kit for RV communication.

The 2022 novelty has finally arrived, which allows quick and easy installation on your camper. Camper kit, which includes M-5, the CB in the microphone with all the controls at hand and the LCD display, combined with the RV65 antenna that does not require piercing the bodywork, with super resistant 3M adhesive. It does not require a ground plane and is installed directly on the glass (Specifications: see table on page 36).

Packaging and codes

1 radio, microphone with Up/Down buttons and LCD display, fixing screws, mounting bracket, power cord with cigarette lighter socket and RV65 antenna.

code KIT253



M-MINI USB

The small CB Radio with USB socket.

Discover the video



**REMOVABLE
MICROPHONE**



Are you looking for a CB radio that's easy to install?

M-Mini USB is your answer: essential, 40 channels, can be powered by connecting it to the cigarette lighter outlet using the power cable included in the package.

On the front, there is a practical USB socket so that you can recharge all your devices: smartphones, tablets... and a RJ45 socket, which makes the microphone removable.

The aluminium chassis is the finishing touch of **M-Mini USB**, making it robust and resistant to any movement.

Features

- 40 AM/FM channels
- Selectable frequency bands: I, 12, DE, EU, EC, PL, UK, IN (see page 36)
- Output power: 4W AM/FM
- Up/Down buttons on the microphone
- Channels scan
- LCD display with S/meter
- Double squelch mode (9 and 28 levels)
- Adjustable reception attenuator (RF gain)
- Emergency channel 9/19
- External loudspeaker socket

- Removable microphone with RG45 connector
- USB recharge socket
- Power cable with cigarette lighter plug

Packaging and codes

Box M-Mini USB

1 radio, microphone with Up/Down buttons, power cord with cigarette lighter plug, fixing screws, mounting bracket.

code C1262.04

EXPORT VERSION 9W AM/FM - 400CH

Blister version

CB GO-USB

Ready to modulate in a few moments with "do it yourself" installation.

A complete pack, containing: M-Mini USB, the Midland multimedia mini-transceiver, power cord with cigarette lighter plug and

Midland LC29 high-performance antenna, fitted with a magnetic base.

Become a part of the CB community

Packaging and codes

Blister CB GO USB

CB M-Mini USB, power cord with cigarette lighter plug, LC29 antenna, magnetic base.

code C1262.05



M ZERO PLUS

The 40-AM-FM-channel CB.

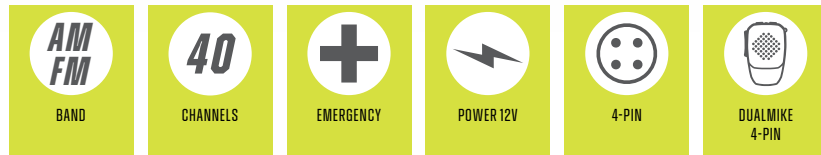

Evolution of the excellent **Midland M-Zero**, the new PLUS version adds the **FM band**.

ABS body for practical and light use and with **SMD technology** for the electronic structure.

With its **40 AM/FM channels**, this CB is extremely easy to use.

M-Zero Plus is definitely the best compromise between quality and price of the M line.

Features

- Band: AM-FM (Poland-Italy)
- Channel display, black background with white texts
- Up/Down buttons
- Squelch control: eliminates annoying background noises in reception
- External loudspeaker socket
- Emergency memory channel: to immediately select the emergency channel (set by the user)
- RF Gain: sensitivity control in RX
- Quick Scan
- On/Off keypad beep
- 4-pin microphone connector

Packaging and codes

1 radio, microphone, mounting bracket, fixing screws
code **C1169.01**

EXPORT VERSION: 120CH

ALAN 100 PLUS B

The historical 40-channel CB.

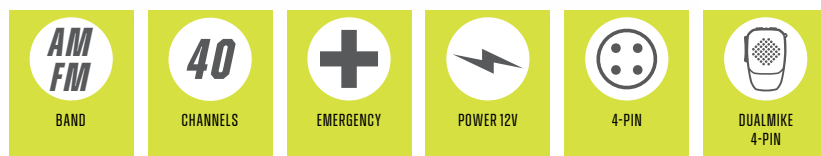

The CB that has accompanied car, caravan and truck drivers since 1998.

An excellent product to enter the CB world with everything that is required to communicate.

An easy communication tool for everyone.

Features

- Band: AM-FM
- Emergency channel 9-19
- Display channels
- Up/Down buttons
- Squelch
- Transmission and reception led
- External speaker socket
- 4-pin microphone connector

Packaging and codes

1 radio, microphone, mounting bracket, fixing screws
code **C442.12**

DUAL MIKE WIRELESS

The Bluetooth microphone of the CBTalk App community.



■ Customisable Light Ring with light indications



Discover the video



Bluetooth™ 4.2

Lose the wire... but remain connected!

The **Dual Mike Wireless** presents itself as a classical CB microphone, but is much more.

Dual Mike Wireless has **dual PTT** in one microphone to use with the CB Talk App and the CB in wireless mode, the **hands-free function** to answer calls and a **superb speaker** to listen to music via Bluetooth.

The new **AGC** (Automatic Gain Control) function allows the **Dual Mike Wireless** to better capture the voice, keeping it at a distance from the mouth from zero to one meter. The connection to the **PTT-Dual in BLE** (Bluetooth low energy - low consumption) allows getting the best out of the **Dual Mike Wireless** in hands-free mode.

Discover its functions with the dedicated **CB Talk app**.

Features

- 3W speaker with Labyrinth™ technology that emphasizes bass tones
- Dual PTT
- 8-band voice equalizer
- ECHO function
- Roger beep
- Smartphone/ Dual Mike distance up to 30m
- Bluetooth V4.2 Wireless Microphone
- Dual USB Micro Recharge socket
- Compatible with wireless charger (via Optional DK-Dual)
- 10h battery life with volume at 50%,
- Weight 153 g
- Preamplified Microphone with DSP (Digital Signal Processor) for a perfect voice
- Multifunction key
- Customisable Light Ring with light indications
- Hands-free function

Packaging and codes

Microphone, recharging USB cable, microphone holder with adhesive support.

code **C1363**

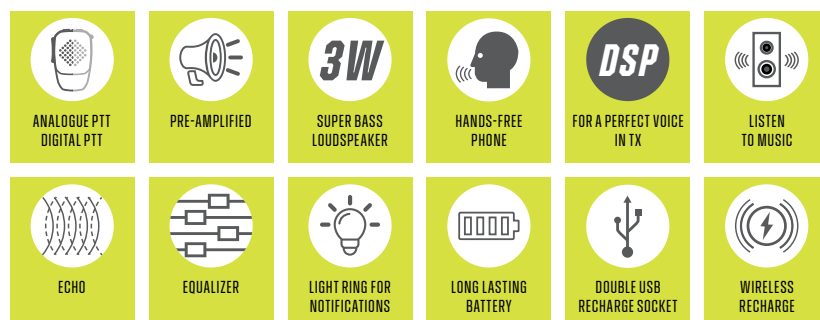

CB HANDSFREE KIT

The 1st hands-free communication system for CB.

Discover the video



 Bluetooth™ 4.2

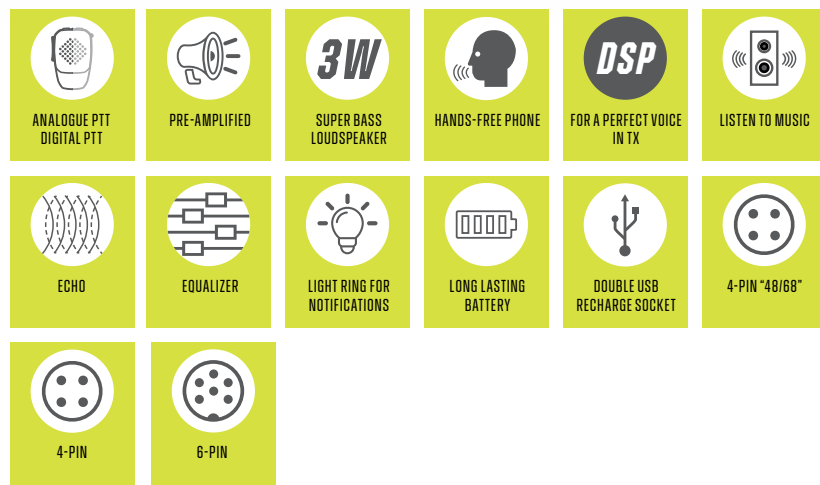

The new MIDLAND kit allows talking via CB while driving, without moving your hands from the steering wheel.

It is precisely the new 2020 Highway Code that allows us to focus on the great potential of the new communication system: the ability to communicate HANDS-FREE by placing the microphone comfortably on the dashboard and pressing a button on the steering wheel.

This system prevents incurring the now harsher penalties provided for those who are caught driving with a CB microphone in hand (even if so far "tolerated") or with a smartphone.

No more distractions. No more fines.

The kit includes: Dual Mike, PTT-Dual with 3 types of attachment, micro-USB recharge cable, microphone holder with adhesive support.

Dual Mike has **dual PTT** in one mike to use with the analogue CB via the CBTalk App, **hands-free** to answer calls, a **superb speaker** to listen to music via Bluetooth. The new **AGC** (Automatic Gain Control) function allows the **Dual Mike** to better capture the voice, keeping it at a distance from the mouth from zero to one meter. The **Dual Mike** connection to the **PTT-Dual** in **BLE** (Bluetooth low energy - low consumption) allows getting the best out of the **Dual Mike** in hands-free mode. **Discover its functions with the dedicated CBTalk app.**

Features

- 3W speaker with Labyrinth™ technology that emphasizes bass tones
- Dual PTT
- 8-band voice equalizer
- ECHO function
- Roger beep
- Smartphone/ Dual Mike distance up to 30m
- Bluetooth V4.2 Wireless Microphone
- Dual USB Micro Recharge socket
- 10h battery life with volume at 50%, 15h with CB only
- Weight 290g with cable
- Multifunction key
- Customisable Light Ring with light indications
- Preamplified Microphone with DSP (Digital Signal Processor) for a perfect voice
- Hands-free function
- Connecting cable to the traditional CB (with 4-Pin 48/68, 4-Pin and 6-Pin connectors)

Packaging and codes

code C1283.03 - 4-Pin 48/68 Kit

code C1283.04 - 4-Pin Kit

code C1283.05 - 6-Pin Kit



PTT-DUAL

Bluetooth button to communicate hands-free while driving... with no penalties! For fans of the digital world.

Bluetooth Low Energy (B.L.E.) button to talk hands-free via CB radio, without taking your hands off the steering wheel.

For Dual Mike and Dual Mike Wireless.

The built-in battery guarantees a duration of 1 year with an average use of 9h/day.

How is the PTT-Dual used?

- 1) Pair with telephone via Bluetooth;
- 2) Place on the steering wheel or in a comfortable position while driving;
- 3) Press the button to answer the phone call or to transmit the voice via the CB Talk App, without ever taking your hands off the wheel.

Packaging and codes

Main PTT, steering wheel mount for main PTT, optional PTT with wire, external PTT finger, 2 velcro stickers, CR2032 lithium battery included.

code **C1488**



CB TALK

The app that connects roads around the world

CB Talk is the revolutionary application that lets you talk to other users in analogue or digital mode.

CB Talk is the free downloadable app used by over 1 million users around the world to talk to friends and colleagues freely. The interface that appears on the App's screen closely resembles the controls found on the widespread Midland Alan 48 CB radio and the functions, although digital and advanced, are very user friendly.

By combining the Dual Mike/Dual Mike Wireless with the CB Talk app, the following features are added: 200km of Squelch, 80 channels, possibility to create public and private groups and the creator is also the administrator of the group.



Download CB Talk App





DUAL HEADSET

Bluetooth headset with built-in transmission button to communicate hands-free.



Good communication with the work group translates into good company management and is achieved thanks to an excellent quality of transmission in real time and a timely passage of information. Maximum comfort and versatility of the headset that can be worn in the right or left ear depending on preference. The MWE noise cancellation algorithm developed by Midland allows the transmission of a perfect voice.

Through the **Dual Headset** you can easily connect to the Midland apps: **CB Talk** and **BT Talk**.

Specifications

- Battery life 8 hours
- Customisable button
- Dual microphone
- Noise cancellation
- Two-colour LED
- USB charge
- Versatility (right or left ear)

Packaging and codes

Bluetooth headset, spare silicone headsets (S/M/L), USB cable code **C1521**

BLUETOOTH MICROPHONES ACCESSORIES

DK-Dual C1364

Docking station: wireless recharge support. For **Dual Mike Wireless**.



VM-Dual C1407

Air vent fixed support. For **Dual Mike Wireless**, **Dual Mike**.



AM-Dual C1408

Dual Mike adhesive support kit. For **Dual Mike Wireless**, **Dual Mike**.



AL-Dual 48 C1403

Voltage reducer 12V-5V and Micro USB for Alan Quarantotto, Alan Sessantotto. For **Dual Mike**, **DK-Dual**.



AL-Dual C1403.01

Voltage reducer 12V-5V and Micro USB for all other Midland CB radios. For **Dual Mike**, **DK-Dual**.



A man with a beard and glasses, wearing a white shirt, is driving a truck. He is holding a black Midland CB microphone in his right hand. On the dashboard, a black Midland CB radio is mounted. The truck's interior is visible, including the steering wheel, dashboard, and gear shift. The background shows a road with trees.

CB ACCESSORIES

MICROPHONES-MICROPHONE HOLDERS-BRACKETS ETC...

4-pin



R51504

Microphone Alan 100 Plus B, Midland 203, Alan 199, Midland 210 DS, M-10 and M Zero Plus.



4-pin "48"



MDL4190 C074

Omni directional dynamic microphone. Impedance 500 Ohm. For Alan 48, Alan 68S, Midland 8001-XT.



4-pin "48"



Mike Midland T059.01

Omni directional dynamic microphone. Impedance 500 Ohm. For Alan 48, Alan 68S, Midland 8001-XT.



6-pin



Mike Multi C714.01

"Precision series" microphone with Up/Down buttons, Lock button. For series Plus Multi, Excel, Midland 248, 248 XL, 278, Alan 121.



6-pin



MR120 C404.01

Electret microphone with Up/Down buttons. For series Pro, Plus Multi, Excel, Midland 248, 248 XL, 278, Alan 121.



Microphone holders

PM3 T431

Microphone holder with screw fastening and bi-adhesive.



Potentiometer

Kit250

Potentiometer kit for Alan Quarantotto, Alan Sessantotto, consisting of 4 pieces.

3x



Speakers

SPM-48 Din C791

DIN bracket for Alan 48 Plus Multi B/Excel Multi, Midland248/248XL, Alan 48 Pro.



SPM-78 Din C792

DIN bracket for Alan 78 Plus Multi B, Midland 278, Midland M20, Alan 78 Pro.

SPM-100 Din C807

DIN bracket for Alan 100 Plus, 100 Plus Euro, Alan 100 Plus B, 199-A, Midland 203, Midland 210, Midland M10.



SA 48 T769

Complete with 1 bracket, 2 slides, 2 handles, 2 screws. For Alan 48, 68S, Alan Quarantotto, Sessantotto.

Cables



R74574

2 m long mike extension cord for M-5/M-30/CT3000.



T060

3-pole lead with fuse-holder. Length: 160 cm. For Alan 48, Alan 68S.

NEW



AU50 EXTREME

The rugged and powerful (20W) external IP67 speaker for vehicle radios.

AU50 Extreme is the additional heavy-duty external speaker for vehicle radios designed by Midland to guarantee premium level audio quality in every situation. On the road, at sea, wherever you are, **the AU50 Extreme** delivers 20 Watts of power. IP 67 certified for watertightness, it is totally protected against dust, sand and any small solid body, as well as resisting immersion up to 1 meter deep for 30 minutes.

These conditions make it the ideal choice for use on boats, ATVs, Quads, etc. but also the perfect travel companion in all situations with loud ambient and background noises, because they are overpowered by the sound emitted.

AU50 Extreme is compatible with most transceivers on the market, thanks to the provision of a 2.10-metre cable that can be connected to the 3.5 mm jack socket.

Specifications

- Exceptional sound, up to 20 Watts of power
- Rated power 15W
- Audio frequency response: 20 Hz / 20 kHz
- Impedance: 8 ohm
- Water and dust resistant (IP67)
- High degree of compatibility with most transceivers, CBs, marine radios, etc.
- Cable length: 2.10 m
- Dimensions (with bracket) 142 x 129 x 110 mm

Packaging and codes

Speaker, 2.10 m cable with 3.5 mm jack.

code **C1574**



NEW



MIKEMAG HOLDER

Magnetic CB microphone holder.

Midland's latest innovation is a magnetic CB microphone holder that can be attached to the dashboard of the car, truck, or 4x4.

The Mikemag holder is a superior-quality, safe and reliable companion for all your trips.

Compatible with all CB microphone models.

Packaging and codes

Microphone holder

code **C1592**



EXTERNAL SPEAKERS

AU 20 T775

External speaker 5W max.
Impedance: **8 Ohm**, Rated power **2 W**
Maximum power **5 W**, Size **65x55x65mm**.



AU 30 T682

External speaker 12W max.
Impedance **8 Ohm**, Rated power **7 W**
Maximum power **12 W**, Size **110x60x60mm**.



AU25E T681.01

External speaker 5W max.
Recommended for VHF professional mobile transceivers Alan HM35/70/06
Impedance **8 Ohm**, Rated power **3 W**
Maximum power **5 W**, Size **100x60x60mm**.



SWR METER WATTMETER

KW 520 C530

Suitable for checking transmitter power and antenna adaptation, with two separate measuring lines, one from 1.8 to 200 MHz and the other from 140 to 525 MHz. This enables the simultaneous connection of 2 systems: one in HF/VHF and the other in VHF/UHF and select which to use to take the measurements with the specific switch. The measurement line selected is displayed by the specific LED. With the possibility of measuring peak or medium value, fine calibration of the index, base scale duplicator button of power from 200 to 400 W.

RF power 5W - 20W - 200W - 400W
R.O.S. 1:1 / ∞
Impedance 52 Ohm
Frequency range 1.8 - 200 MHz/140 - 525 MHz
Size in mm 155x100x60
Weight 730 g
Connector SO239



POWER SUPPLIES

SW35 47500

Input voltage 220-230Vac-50Hz
Output voltage 13.8Vdc
Rated output current Max 3-5A



SW57 47510

Input voltage 220-230Vac-50Hz
Output voltage 13.8Vdc
Rated output current Max 5-7



SW79 47520

Input voltage 220-230Vac-50Hz
Output voltage 13.8Vdc
Rated output current Max 7-9A



SW102 47530

Input voltage 220-230Vac-50Hz
Output voltage 13.8Vdc
Rated output current Max 10-12A



CAR AND TRUCK CB ANTENNAS

Lux antennas: illuminate when transmitting

Midland Lux is the genesis of a new line of CB antennas, designed to make the installation of the best "CB radio" on vehicles unique. The antenna base is fitted with a wave guide that glows when it is crossed by radio frequency. It automatically illuminates when the radio is transmitting, thus signalling the correct operation of the device. It does not need any power and is totally waterproof. **LUX1500-S** and **LUX 1000-S**: Anti-theft and protection hinge. **LUX 1500-PL** and **LUX 700-PL** suitable for gutter, mirror, centre roof mount (accessories not included). With the **KIT** they become magnetic (see page 70).



Lux 1000-S
C1258



Lux 1500-S
C1259



Lux 700-PL
C1330



Lux 1500-PL
C1257



X-Turbo 60
C871



X-Turbo 80
C872



ML143
C1164



ML 145
T562.01



Alan PC 4
T739



Alan PC 6
T736

CAR AND TRUCK CB ANTENNAS



Alan PC 8
T701

Alan S9 Plus
T638

Funk 90
T638.04

Funk 130
T638.05

Funk 150
T638.06

Mini
C593

CAMPER CB ANTENNA

Enables easy and quick installation
on your camper.

RV65 C1558

A good antenna allows the CB transceiver to work at its best.

RV65 in fact avoids piercing the bodywork and has a super resistant 3M adhesive, top of the range of its kind. It does not require a ground surface, so unlike the antennas normally on the market, RV 65 is installed directly on the glass.

Our antennas have a well-structured radial system, essential for obtaining optimal propagation and durability over time.

See also page 57.



MAGNETIC CB ANTENNAS



Kit 226
Lux 700-PL+120/PL

Kit224
Lux 1500-PL+120/PL



High power antenna with magnetic base
Ø 120mm

Kit 212
ML143+Base M

Kit 007
ML145 + 120/PL

LC29
C1018

LC65
C1020

MAGNETIC BASES, BALCONY/BASE AND VHF/UHF ANTENNAS

Vehicle magnetic antenna

MC45 C1559

Vehicle antenna operating on the 26-28MHz band. MC45 is equipped with a magnetic base, therefore it must be installed on a metal surface of at least 1 m². The stylus is made of stainless steel and is protected by a heat shrink sleeve. The connection cable to the RG-174 radio is 4.5 m long. The magnetic force of the antenna is guaranteed up to a speed of 140 km/h.



CB base antennas

EQUIPPED WITH A SYSTEM TO PROTECT AGAINST WATER LEAK

EQUIPPED WITH A SYSTEM TO PROTECT AGAINST WATER LEAK

Energy New 1/2 T241.02

Energy New 1/2 is a telescopic base antenna, ground plane at 1/2 lambda, operating on 27MHz, built in anti-corrosion aluminium. All elements are telescopic and facilitate installation.

Energy New 5/8 T242.02

Energy New 5/8 is a telescopic base antenna, ground plane at 5/8 lambda, operating on 27MHz, built in anti-corrosion aluminium. All elements are telescopic and facilitate installation.



Magnetic bases

BM-MLC143 C1183

Developed for the ML 143 antenna, it is designed to withstand high speed. Equipped with scratch resistant magnet-covering cap. Supplied with PL mount (already installed).

120/PL T036

Designed to withstand high speeds. Equipped with scratch resistant magnet-covering cap. Supplied with attachment for PL (already installed).



VHF/UHF antenna

VH 1 F092



BRACKET/MOUNTS, CONNECTORS AND ANTENNAS CABLES

Bracket/Mounts

NEW

GR-L C1047

Stainless steel mount.
Size: 38x64x99mm

GR-XL C1048

Stainless steel mount
Size: 38x100x180mm



Trunk PL C1616

CB antenna bonnet mount that requires no drilling of bodywork.

Intended to be used for any type of on-vehicle transceiver (CB, professional, amateur or nautical). **Trunk PL** is equipped with a 6-metre cable with detachable radio-side connector to allow easy routing of the cable through the vehicle.

This simple universal antenna mount is perfect for anyone wishing to avoid the need to drill holes in their vehicle, but seeking a solid antenna support that delivers reliable communications both on- and off-road.

Not suitable for fibreglass bonnets.

The SO239 connector means any antenna equipped with a PL259 connector can be used.

SP 21 T390

Mirror mount. Enables the installation of any mobile antenna on the rear view mirror, avoiding unsightly holes in the bodywork.



DV 27 PL T599

Centre roof adapter
DV/SO239.



SC 27 T441

Special screw.



LC 27/10-N T370.01

Connector.



FC 27 T478

Antenna base with screw, connector for FC 27 and base for Midland antennas.



Connectors

PL259/R T292.02



PL 259/RL T377



PL 259 T205

Connector for
RG8/RG213 cables.



UG 255 F076

Connector for
BNC/SO239.



SA 95 T211

SO239 connector
RCA plug.



Cables

3-piece lead for roof centre mount.
Length: 4m
R73895 for PC antennas.



R 45/58-U T194

RG58 connection cable for CB
transceivers. Length: 45 cm
2 connectors PL259.



Centre roof mount T301

RG58 cable with Centre-roof
mount for US antennas.
Length: 3.5 m.



R 90/58-U T193

RG58 connection cable for
CB transceivers.
Length: 90 cm
2 connectors PL259.



ANTENNAS SPECIFICATIONS

Specifications	LUX 1000-S/LUX 1500-S	X-TURBO 60/80	ALAN PC 4/6/8	ALAN S9 PLUS
Operating frequency	26-30MHz	26-28 MHz	25-30 MHz	25-30 MHz
Number of channels	120	200	150/240/130	200
Maximum applicable power	600/800	800 W (max 1500) 1000 W (max 1700)	400/600/800 W	300 W
R.O.S. min. in centre band	< 1.2	< 1.2	< 1.2	< 1.2
Length (cm)	120/170	160/180	115/160/163	155
Impedance (Ohm)	50	50	50	50
Weight (g)	503/525	670/690	450	390
Whip material	Steel	Steel	Steel	Steel
Antenna connection type	3 pieces	3 pieces	3 pieces	DV
Hole diameter (mm)	12.5	10	10	12.5
Lead (m)	4	4	4	4

Specifications	FUNK 90/130/150	MINI	Kit226 (Lux700-PL)	Kit224 (Lux1500-PL)
Operating frequency	26-28 MHz	26÷28 MHz	26-28 MHz	26-28 MHz
Number of channels	-	40	40	120
Maximum applicable power	200/250/300 W	80 W	600 W pep	1000 W pep
R.O.S. min. in centre band	< 1.2	1.2:1	< 1.2	< 1.2
Length (cm)	90/130/150	68	90	164.5
Impedance (Ohm)	50	50	50	50
Weight (g)	160/190/200	210	330	358
Whip material	Steel	Stainless steel	Stainless steel	Stainless steel
Antenna connection type	DV	3 pieces	Magn. base 120mm with PL (SO239 antenna only)	Magn. base 120mm with PL (SO239 antenna only)
Hole diameter (mm)	10	12.5	16 (without magn. base)	16 (without magn. base)
Lead (m)	4/4/4	4 with PL259	4	4

Specifications	Kit212 (ML143)	Kit007 (ML145)	LC29	LC65
Operating frequency	26-28 MHz	26-28 MHz	26-28 MHz	26.965-27.405 MHz
Number of channels	120	90	40	40
Maximum applicable power	300 W pep	400 W pep	10/30 W (peak)	60/300 W (peak)
R.O.S. min. in centre band	< 1.2	< 1.2	≤ 1.2:1	≤ 1.2:1
Length (cm)	170	146	29	115
Impedance (Ohm)	50	50	50	50
Weight (g)	1500	1600	400	1000
Whip material	Stainless steel	Stainless steel	Stainless steel	Stainless steel
Antenna connection type	Magn. base 120mm with PL (SO239 antenna only)	Magn. base 120mm with PL (SO239 antenna only)	Magn. base Ø 68 mm with PL	Magn. base Ø 120mm with PL
Hole diameter (mm)	16 (without magn. base)	16	-	-
Lead (m)	4		4	

Specifications	BM-MLC143	120/PL	BM-150PL	BM Mini
Frequency range	26-460 MHz	26-460 MHz	26-460 MHz	26-460 MHz
Max. speed	80/130 Km/h	80/130 Km/h	80/130 Km/h	80/130 Km/h
Base diameter	Ø 120 mm	Ø 120 mm	Ø 150 mm	Ø 35 mm
Weight	940 g	700 g	800 g	100 g
Lead	4 m	3 m	3.9 m	2.4 m

ANTENNAS SPECIFICATIONS

Specifications	MC45	Specifications	MC45
Frequency	26-28 MHz	Whip material	Stainless steel
Max. speed	140 km/h	Weight	165 g
Maximum applicable power	180 W	Polarization	Vertical
Impedance	50 Ohm	Connector	PL259
R.O.S. min. in centre band	< 1.2	Lead	RG-174
Length (cm)	450 mm		

Specifications	RV65	Energy New 1/2	Energy New 5/8	VHF1
Operating frequency	26-28 MHz	25-29 MHz	25-29 MHz	108-550 MHz
Maximum applicable power	10 W (peak)	500 W PEP	500 W	100 W
Type	-	-	-	-
Channels number	40	-	-	-
Impedance	50 Ohm	50 Ohm	50 Ohm	50 Ohm
Band R.O.S.	< 1.2	1.2:1	1.2:1	1:1.2
Length (cm)	65	575	650	51
Weight	300 g	2.1/ 2.5 Kg	2.5 Kg	300 g
Ø support pole	-	30-40 mm	30-40 mm	-
Connector	PL	SO 239	SO239	PL259 (not supplied)
Whip	Steel	Aluminium	Aluminium	Steel
Hole diameter	-	-	-	12 mm
Lead	5 m	-	-	4 m

TABLE OF CHANNELS/POWER/BAND FOR MULTI CB

Code	Country	MHz
I	Italy 40 CH AM / FM 4 Watt	26.965-27.405
I2	Italy 34 CH AM / FM 4 Watt	26.875-27.265
D4	Germany 80 CH FM 4 Watt / 40 CH AM 4 Watt	26.565-27.405
EU	Europe 40 CH FM 4 Watt / 40 CH AM 1 Watt	26.965-27.405
EC	CEPT 40 CH FM 4 Watt	26.965-27.405
E	Spain 40 CH AM/FM 4 Watt	26.965-27.405
F	France 40 CH FM 4 Watt / 40 CH AM 4 Watt	26.965-27.405
PL	Poland 40 CH AM/FM 4 Watt	26.960-27.400
UK	England 40 CH FM 4 Watt + EC (40 CH FM 4Watt CEPT) or + I Italy 40CH AM/FM 4W (it depends on the radio model)	27.60125-27.99125 + 26.965-27.405
Code	Export Version	MHz
RU	Russia 400 CH AM/FM 4 Watt	25.615-30.105
PX	Poland 400 CH AM/FM 4 Watt Polish frequencies	25.610-30.100
SW	Sweden 24 CH FM 4 Watt 31 MHz	30.930-31.570
AU	Australia 40 CH AM 4 Watt	26.965-27.405
AM	Australia 10 CH AM 4 Watt	27.680-27.980
NZ	New Zealand 40 CH AM 4 Watt	26.330-26.770

**40-CHANNEL
CB: FREE USE
IN ITALY AND
EUROPE**

NB: the multi CB radios can have different use bands, in any case included in the above table. For further information, please check the user manuals that can be downloaded on midlandeurope.com in the **Product section**.

GB OVERVIEW TABLES

Model	Alan 42 DS	Midland 88
Type	Portable multiband CB	Vehicle multiband CB
General		
Channels/Bands	See multi equipment table page 74	See multi equipment table page 74
Frequency range	26.565 MHz - 27.99125 MHz	26.565 - 27.99125 MHz
Power supply	12.6 Vdc ± 10%	12/24Vdc
Size (WxHxD)/weight	70 x 140 x 30 mm/220 g (- batt)	188x57x77/677g
Mic. connector	2-pin Midland	6-pin
Receiver		
Sensitivity for 20dB Sinad	< 1 µV	< 1 µV
Audio output power	0.5W	> 3W
Audio distortion	3% @ 1 kHz	<3% @ 1 kHz
Transmitter		
Output power	1W/4W AM-FM	4W AM/FM
Modulation	AM 90% ±5%, FM 2 kHz	AM: 90%; FM: 1.9 kHz
Max. current drain	900mA	<2000mA

Model	Alan 48 Pro	Alan 78 Pro	Alan Quarantotto
Type	Vehicle multiband CB	Vehicle multiband CB	Vehicle AM-FM CB
General			
Channels/Bands	See multi equipment table page 74	See multi equipment table page 74	40 AM -40 FM
Frequency range	26.565 - 27.99125 MHz	26.565 - 27.99125 MHz	26.965 - 27.405 MHz
Power supply	12/24Vdc	12/24Vdc	12.6 V DC ± 10%
Size (WxHxD)/weight	180 x 50 x 150 mm/1 Kg	180 x 35 x 140 mm/0.850 Kg	165 x 55 x 205 mm/1.5 Kg
Mic. connector	6-pin	6-pin	4-pin "48"
Receiver			
Sensitivity for 20dB Sinad	0.5±1 µV	< 1 µV	<1µV
Audio output power	> 3W	> 2W	4W max
Audio distortion	< 8% @ 1 kHz	< 8% @ 1 kHz	< 5% @ 1 kHz
Transmitter			
Output power	1W/4W AM-FM	1W/4W AM-FM	4W AM-FM
Modulation	AM: 90%, FM: 1.8 kHz +/- 0.2 kHz	AM: 90%, FM: 1.8 kHz +/- 0.2 kHz	AM 90% ±5%, FM 2 kHz
Max. current drain	1100mA	1100mA	1500mA

GB OVERVIEW TABLES

Model	Alan Sessantotto	Midland M-30	Midland M-5
Type	Vehicle AM-FM CB	Vehicle multiband CB	Vehicle multiband CB
General			
Channels/Bands	34 AM-FM	See multi equipment table page 74	See multi equipment table page 74
Frequency range	26.875 MHz - 27.265 MHz	26.565 - 27.99125 MHz	26.565 - 27.99125 MHz
Power supply	12.6 Vdc ± 10%	12÷24V	12.6 V DC ± 10%
Size (WxHxD)/weight	165 x 55 x 205 mm/1.5 Kg	120x37x160 mm/820 g	110x120x25 mm/380 g
Mic. connector	4-pin "48"	RJ45	RJ45
Receiver			
Sensitivity for 20dB Sinad	<1µV	<1µV	<1µV
Audio output power	4W max	4W max	3W+2W
Audio distortion	< 5% @ 1 kHz	< 5% @ 1 kHz	< 5% @ 1 kHz
Transmitter			
Output power	4W AM-FM	4W AM-FM	1W/4W AM-FM
Modulation	AM 90% ±5%, FM 2 kHz	AM 90% ±5%, FM 2 kHz	AM 90% ±5%, FM 2 kHz
Max. current drain	1500mA	2000mA	<1600mA

Model	Midland M-Mini USB	M Zero Plus	Alan 100 Plus B
Type	Vehicle multiband CB	Vehicle AM-FM CB	Vehicle AM-FM CB
General			
Channels/Bands	See multi equipment table page 74	40 AM/40 AM -40 FM	40 AM-40 FM
Frequency range	26.565 - 27.99125 MHz	26.965 - 27.405 MHz	26.965 - 27.405 MHz
Power supply	12.6 V DC ± 10%	12.6 Vdc ± 10%	12.6 Vdc ± 10%
Size (WxHxD)/weight	102x100x25 mm/450 g	110 x 45 x 140 mm/665 g	124x38x190 mm/1.2 Kg
Mic. connector	RJ45	4-pin	4-pin
Receiver			
Sensitivity for 20dB Sinad	<1µV	< 1µV	< 1 µV
Audio output power	4W max	2W max	4.5 W max
Audio distortion	< 5% @ 1 kHz	< 5% @ 1 kHz	< 8% @ 1 kHz
Transmitter			
Output power	1W/4W AM-FM	4W AM-FM	4W AM-FM
Modulation	AM 90% ±5%, FM 2 kHz	AM: 90% - FM 2 kHz	AM: 90%, FM: 2 kHz
Max. current drain	<1600mA	1500mA	1100mA

VIDEO CAMERAS

WILD CAM | DASH CAM | ACTION CAM | WEB CAM



 MIDLAND®

CHOOSING YOUR VIDEO CAMERA

MOTORCYCLE/CAR



Need to monitor and record videos while riding your motorcycle? Or inside and outside your car?

Bike Guardian Pro
Bike Guardian

CAMPER/TRUCK



Need surveillance for your vehicle or help while conducting manoeuvres?

Truck Guardian Pro
Truck Guardian Wired
Wireless RV Cam

OUTDOOR



Want to capture film footage of animals in their natural environment?

Wild Guardian

Wild Guardian Wi-Fi

SMARTWORKING



Smart working or working alone oftentimes requires meetings and sharing.

W199

Follow U



Are you an outdoor enthusiast seeking to capture your adventures on video?

H9 Pro

H5 Pro

H3 +

NEW: MIDLAND TRAP CAMERAS

Discover the power of surveillance with Midland trap cameras!

Thanks to their advanced motion sensor, these trap cameras capture snapshots and videos of anything that moves in front of them. They never stop: operating both day and night, thanks to powerful infrared LEDs that ensure sharp images even in the darkest hours. Capture every moment with the precision and reliability of Midland trail cameras. In addition to hunting, trail cameras are the ideal tools for studying wildlife and protecting crops and properties from animal damage. They are also used for outdoor security surveillance (country houses, fields, wooded areas) and against illegal waste dumping in public and private areas.

Security becomes an art with advanced technology at your fingertips.

WILD GUARDIAN WI-FI

Innovative wireless video surveillance system that captures every movement day and night.



4K
ULTRA HD



Wild Guardian Wi-Fi has been designed to record animal film footage during the day and also at night by means of **infrared LEDs** (46 LEDs) and outstanding **image quality** (24 megapixels). When the trap camera is positioned in places that are difficult to access, thanks to the **Wi-Fi connection** it can be managed remotely directly from your smartphone via the App (Android and iOS), to adjust the settings and view the footage in real time on your phone.

The incredibly fast activation time of just **0.4 seconds** and wide **70-degree viewing angle** allow you to reliably capture every smallest detail of any animals passing in front of its field of view – even for just a few moments.

The possibility of choosing between the **three modes of use**: Photo, Video and Photo/video allows the optimization of battery consumption, determined by the number of activations of the shooting system.

The integrated 2-inch display makes setting up the camera extremely simple and fast, with the possibility of immediately reviewing what has been recorded.

With a mimetic look to best camouflage in the surrounding environment, **Wild Guardian Wi-Fi** is not afraid of adverse weather conditions: it is **water** and dust **resistant** according to the international IP65 standard.

Packaging and codes

Video camera, mounting base, jointed screw support, USB-C cable, fixing belt, screws and plugs.

code **C1623**

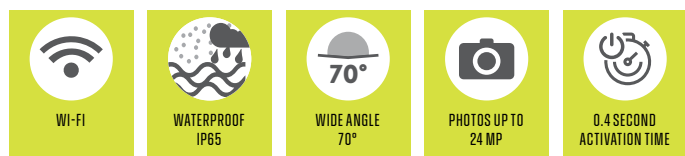



WILD GUARDIAN

Innovative video surveillance system that captures every movement – day and night.

4K
ULTRA HD



The **Wild Guardian** trap camera is designed to record the movements of animals, both day and night, thanks to 10 infrared LEDs. During the night hours, visibility is guaranteed up to 15 meters, ensuring clear images even in low light conditions.

The excellent resolution of **20 megapixels**, the incredibly fast trigger time of just **0.4 seconds** and the wide **viewing angle of 70 degrees** allow you to reliably capture every minute detail of the animals that cross its view even for just a few moments.

The possibility of choosing between the **three modes of use**: Photo, Video and Photo/video allows the optimization of battery consumption, determined by the number of activations of the shooting system.

The integrated 2-inch display makes setting up the camera extremely simple and fast, with the possibility of immediately reviewing what has been recorded.

With a mimetic look to best camouflage in the surrounding environment, **Wild Guardian** is not afraid of adverse weather conditions: it is **water** and **dust resistant** according to the international IP65 standard.

Packaging and codes

Video camera, mounting base, jointed screw support, USB-C cable, fixing belt, screws and plugs.

code C1622

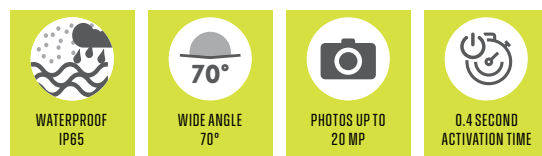

BIKE GUARDIAN PRO

More high-tech, more safety, more emotions.

2K
QUAD HD



NEW

Bike Guardian Pro is the motorcycle dash cam designed by Midland to guarantee the total safety of your vehicle. This model offers unprecedented video quality thanks to the latest generation processor which, combined with the 2K resolution and the Sony sensor, makes the images even sharper.

The use of recorded content becomes more and more pleasant: the **image stabilizer** reduces the oscillations caused by the vibrations produced by driving on the road and the microphone sensitivity adjustment reduces the background noise generated by the wind, for superior audio quality.

Integrated Wi-Fi means seamless connectivity to the camera, allowing live streaming and remote control of images using a smartphone or tablet.

Bike Guardian Pro, certified **Waterproof IP65**, is water-resistant and its entirely aluminium body makes it shock-proof. Perfect features also for any outdoor activity.

Dash cam/action cam mode

Perfect for motorcycles, ideal for all outdoor activities.

Superior video quality

With 2K resolution, Sony sensor, 2h of battery life and latest generation processor

Integrated Wi-Fi

Control via the Vsysto app provides live streaming.

Unique recordings

Image stabilizer and microphone sensitivity adjustment.



Packaging and codes

Video camera, handlebar mount, camera support for handlebar mount, adaptor for different diameter tubes, rapid-mount video camera support, quick fit slide mount, bi-adhesive tape for slide mount, quick fit, fixing screw for quick fit, Allen key, USB-C cable.
code C1593

 WI-FI	 WATERPROOF IP65	 170° WIDE ANGLE 170°	 ADJUSTABLE MIC SENSITIVITY	 SONY CCD SENSOR	 IMAGE STABILIZER
 DUAL 600MHZ PROCESSOR	 MEMORY CARD UP TO 256GB	 2K 2304X1296P			

BIKE GUARDIAN PRO

TOP QUALITY.



BIKE GUARDIAN

The first motorcycle dash cam.

1080P
FULL HD

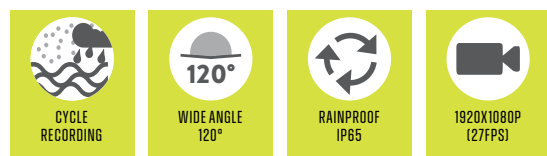

■ **Waterproof USB cable included**
(available also as an option - C1457)

Bike Guardian, the motorcycle camera with FullHD resolution, designed and made to be another “eye” that records everything that happens while you are riding.

Highly useful in the event of an accident to prove who was involved and who was to blame.

Bike Guardian is the first motorcycle camera with continuous recording.

Connected to the motorcycle USB socket with the cable supplied, it starts recording automatically when the motorcycle is switched on and turns itself off when it is switched off.

Bike guardian can be used also as a traditional action cam and, thanks to its integrated battery, allows up to 2 hours recording.

Integrated microphone and speaker.

Rainproof

Bike Guardian is able to withstand bad weather, mud and dust, ensuring a video without interruptions. Even the cable, which connects the camera to the motorcycle socket, is rainproof.

Packaging and codes

Video camera, lock mount, handlebar mount, bi-adhesive flat mount, bi-adhesive curved mount, quick fixing, screw, GO-PRO adaptor, strap mount, USB cable, USB rainproof cable, wrist belt.
code **C1415**



TRUCK GUARDIAN WIRED

The wired surveillance camera for large-sized vehicles.

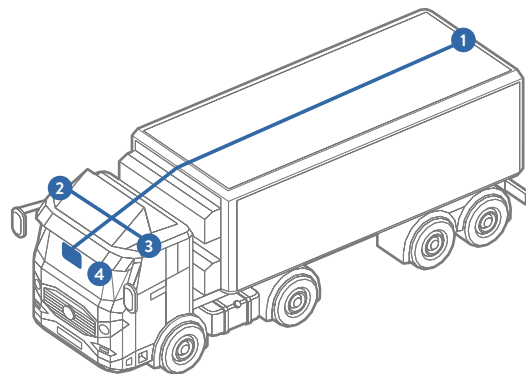

- Connect up to 3 cameras
- Night vision



NEW

Truck Guardian Wired is the wired version of the Truck Guardian Pro truck camera, designed to improve manoeuvring visibility and vehicle safety.

Equipped with a trigger for up to 3 cameras and a menu that can be customised remotely with the remote control, this new model is even more stable and cost-effective. The monitor and camera kit with 18 infrared LEDs is a perfect driving aid both by day and by night.

No more blind spots with Truck Guardian Wired

High-resolution monitor

Truck Guardian Wired is equipped with a Full HD TFT LCD monitor.

Customised footage

With trigger for up to 3 cameras and activation control. Possibility to rotate and mirror the image (based on how the camera is installed), and to have a full-screen view of the installed cameras.

Night vision and brightness control

18 infrared LEDs ensure optimum viewing during darkness. Monitor equipped with automatic brightness adjustment.

Packaging and codes

Monitor and camera fitted with sun shield, power cable and camera connection (for monitor), 20m extension cable for connecting monitor to camera, remote control, monitor mount support, Allen key, bi-adhesive tape.

code C1617 Truck Guardian Wired (monitor and camera)
code C1618 Truck Camera Wired (camera only)

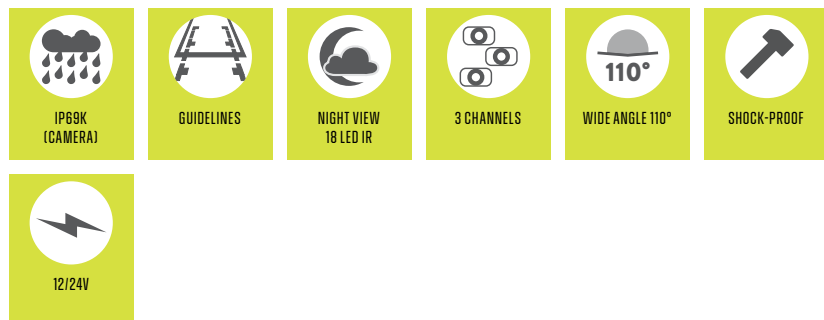

TRUCK GUARDIAN PRO

Professional wireless video surveillance system.

NEW

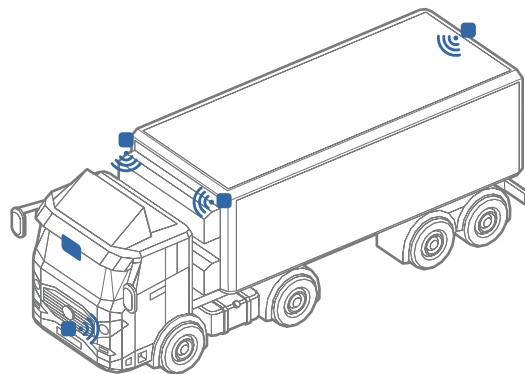

- Extremely easy wireless installation
- With digital recorder (SD card)
- Connect up to 4 cameras
- Night vision

Truck Guardian Pro is a very useful truck camera as an aid during manoeuvres and driving support, also thanks to the reversing video camera. It also becomes an invaluable aid for trailer surveillance. Truck Guardian Pro is a kit made up of a monitor + video camera that can help the truck driver with extra control, thanks to recording on an SD card.

The perfect kit to make every trucker's life easier.

Manoeuvring aid

thanks to the reversing camera.

Trailer surveillance

both internal and external.

Night vision

thanks to the 18 infrared LEDs. In addition, a 7" monitor with an improved resolution from 480p to 1080p which provides sharper images.

Wide range

guarantees good image reception even in trailing or armoured vehicles.

Scalability

Possibility to add up to 4 cameras.

Packaging and codes

Truck Guardian Pro

Monitor with Wi-Fi antenna, sun shield, bracket and fixing screws, camera with Wi-Fi antenna, bi-adhesive tape and Allen key.

code **C1512**

Additional Truck Camera Pro

Video camera with Wi-Fi antenna and sun shield.

code **C1535**



1080P
FULL HD

 WIRELESS UP TO 200 M	 IP69K (CAMERA)	 7" MONITOR	 NIGHT VISION 18 IR LED	 CYCLE RECORDING	 100° WIDE ANGLE 100°
 12 / 24V	 VIDEO RESOL. 1080P (60FPS)	 SUPPORTS 128GB SD CARD			





TRUCK GUARDIAN PRO

EASE OF INSTALLATION AND SAFETY: WIRELESS, WITH BUILT-IN DIGITAL RECORDER.



WIRELESS RV CAM

THE PLUG & PLAY REVERSE
GEAR KIT FOR RV



WIRELESS RV CAM

“Plug & Play” reversing camera kit for campers.

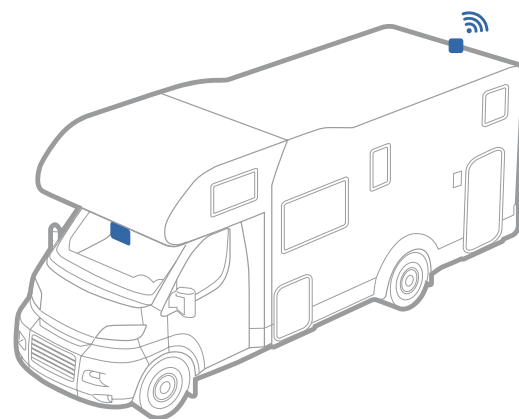

■ Extremely easy wireless installation



Wireless RV Cam has an immediate installation thanks to the suction cup mount of the monitor and the magnetic base of the camera that do not require any configuration. The wireless rear view camera can eliminate most blind spots and offers safer angled viewing when reversing.

Ideal for motorhomes, campers or caravans.

The switching on and off is automatic, it does not require external power supply as it is equipped with an integrated 2160mAh lithium battery.

Plug & Play

Setting up the Wireless RV Cam is super simple. The video camera can only be fixed with the magnetic base (therefore removable) or with screws (the camera can also be removed from the mount).

Automatic

The switching on and off is automatic, so Wireless RV Cam does not need any external power supply. The built-in 2160mAh lithium battery has an autonomy of 6-8h (continuous use).

Maximum comfort







Other than being an aid in manoeuvring (including trailer coupling), Wireless RV Cam carries out surveillance in the rear of the vehicle or from inside the trailer, etc.

Packaging and codes

Video camera with magnetic attachment base, monitor, suction cup mount, USB charging cable/jack, adhesive velcro fastening, fastening screws.

code C1556



 WIRELESS UP TO 20M	 IP67 (CAMERA)	 4.3" MONITOR	 NIGHT VISION 12' IR LED	 PLUG & PLAY	 WIDE-ANGLE 120°
---	--	---	---	--	---

H9 PRO

THE TOP OF THE RANGE OF MIDLAND ACTION CAMS

Discover the video



H9 PRO

The top of the range of Midland action cams dresses in black with triple functions.



4K
ULTRA HD

WI-FI	SUBMERSIBLE CASE 30M	2" LCD DISPLAY TOUCH SCREEN	VIDEO/PHOTO	WEB CAM	CYCLE RECORDING
DIVING MODE	IMAGE STABILIZER	TIME LAPSE VIDEO/PHOTO	MOTION DETECTION	SELECTABLE WIDE ANGLE	

- External Microphone micro USB for H9 Pro C1531
- External USB-C Microphone for H5 Pro/H9 Pro C1582



H9 changes its look and triples its functions in the **Pro** version. Perfect for your moments of madness with 4K HD resolution, 30fps and 20MP, viewing angle adjustable from the menu: 100°, 110°, 130°. It is waterproof up to 30m underwater, has an autonomy of 2 hours and 128GB of memory to record up to 18 hours of video. The touch screen also provides more efficient, intuitive and faster operation than other cameras without a touch screen. You can control the camera with the remote control and manage it via the dedicated app: iSmart DV.

Triple function

Action Cam/Dash Cam/WebCam

Display touch screen

The 2-inch IPS display shows a clearer and brighter image than LCDs, and the touch screen ensures faster, more efficient, intuitive operation than other cameras that do not have it.

7 video modes

Loop, time-lapse, slow motion, fast motion, dash cam, web cam, diving. And it has 5 photo modes: normal, burst, timed, self-timer, long exposure.

High performance microphone

Automatic suppression of noise and wind thanks to the WNR (wind noise reduction) function.

For motorcycle use

An external microphone is available to comment on your travels or record the roar of your engine (optional accessory, code C1531)

Waterproof

Waterproof case up to 30m.

Wi-Fi

It is easy to use even from a distance: thanks to the built-in Wi-Fi, through smartphone or tablet (iOS and Android) up to 15 m.



Packaging and codes







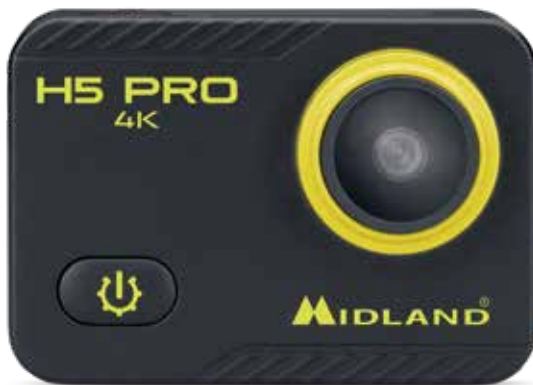

30m waterproof case, handlebar mount, 1050mAh Li-Ion battery pack, quick coupling (x2), screw coupling, 90° support (x2), coupling with photographic screw, 180° support, flat base support (x2), USB cable, clamps, fastening clamps, metal clamp, cleaning cloth.
code C1518

H5 PRO

The action cam to relive all the colours and details of your adventures.



4K
ULTRA HD

 WI-FI	 SUBMERSIBLE CASE 30M	 2" LCD DISPLAY	 VIDEO/PHOTO	 WEB CAM	 IMAGE STABILIZER
 TIME LAPSE VIDEO/PHOTO	 CYCLE RECORDING	 WIDE ANGLE 120°			

■ External USB-C Microphone for H5 Pro/H9 Pro C1582



H5 changes look and becomes **Pro**, bringing video quality to 4K 30fps!

The equipment includes integrated Wi-Fi, 4K recording, 2" rear LCD display, image stabilizer and waterproof case.

The **H5 Pro** action cam can be controlled remotely from a smartphone or tablet thanks to the **DV King 4K** application.

Integrated Wi-Fi

Managed via the app.

Image stabilizer

Automatic elimination of micro vibrations, to achieve jitter-free video recording.

Use flexibility

It adapts to work and leisure requirements. Complete with numerous accessories.

Wide angle

Equipped with 120° wide angle lens for excellent shooting.

Time Lapse

Take great videos with the advanced Time Lapse feature.

2" LCD display

Midland H5 Pro features the integrated display for framing, easily adjusting settings and playing back videos and photos.

30m waterproof case

The submersible case supplied protects the action cam from water up to a depth of 30 metres, but also from mud and dust.



Packaging and codes

30 m waterproof case, handlebar mount, 1050mAh Li-Ion battery pack, quick coupling (x2), screw coupling, 90° support (x2), coupling with photographic screw, 180° support, flat base support (x2), USB cable, clamps, fastening clamps, metal clamp, cleaning cloth.

code C1515

H3+

The action cam everyone can use.



H3+ is complete with integrated Wi-Fi, Full HD, image stabilizer and waterproof case. The action cam for all your craziest moments.

With the **GoPlus Cam** application, you can control the video camera remotely using a smartphone or tablet.

Integrated 2" LCD screen

Midland H3 + features the integrated display for framing, easily adjusting settings and playing videos and photos.

Wi-Fi

Thanks to the integrated Wi-Fi, Midland H3 + connects to smartphones and tablets to view, review and share videos and photos through the dedicated GoPlus Cam App (iOS and Android).

Motion detection

Automatic recording, sensitive to the movements of the wearer.

Dash cam

Continuous recording when connected to an external power supply (car/motorcycle).

Image stabilizer

Automatic elimination of micro vibrations

Waterproof case 30m

The submersible case supplied protects the action cam from water up to a depth of 30 metres, but also from mud and dust.









Packaging and codes

Video camera, case waterproof to 30m, frame, quick fixing, flat based mounting, photographic fixing with screw, USB cable, Li-Ion battery pack

code **C1235.01**

1080P
FULL HD

 WI-FI	 SUBMERSIBLE CASE 30M	 2" LCD DISPLAY	 VIDEO/PHOTO	 CAR DVR	 IMAGE STABILIZER
--	--	---	--	--	--

140°
WIDE ANGLE
140°

W199

The perfect webcam for smartworking.

1080P
FULL HD

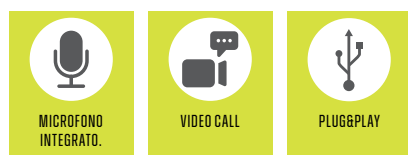

A simple product, but in-between times: you connect it and immediately start shooting in HD, with built-in microphone, with a "Smart" price. The perfect solution for those who need to interact through live audio and video. Stay at home, but always connected with the **W199** web cam.

Features

- Sensor: CMOS
- Autofocus, exposure and white balancing
- Built-in digital microphone
- Cable length: 1.5 m
- Photo supported files: jpeg, yuy2
- Screenshot files: jpeg, png, bmp
- Clip to hang it on the computer
- Weight: 140 g - Dimensions: 7x2.5x2 cm

Packaging and codes

Webcam, USB 2.0 cable
code **C1476**

FOLLOW U

The 360° webcam that follows you up to a distance of 3m.

1080P
FULL HD

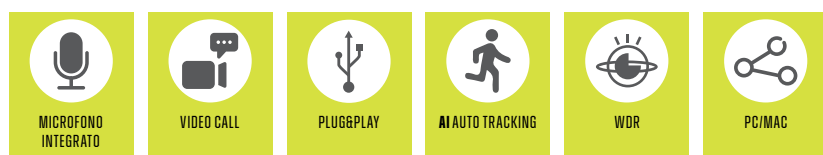

Follow U is the perfect webcam for those who need to move during the live broadcast. The Follow U webcam can in fact recognize the human physiognomy and follow the interlocutor thanks to the innovative LTS® (Live Tracking System) function.

A simple product to install: you connect it and immediately start shooting in Full HD (1920*1080px), with double integrated microphone and compatible with the most used systems such as Skype, Zoom, FaceTime, Facebook, YouTube, PotPlayer etc.

Features

- LTS® function (Live Tracking System) precise and intelligent recognition of human physiognomy
- Automatic 360° rotation
- Built-in stereo microphone
- Plug&Play, no installation drivers required
- 1 Touch Button Tracking, lightly touch the webcam to enable/disable the LTS® function
- WDR® (Wide Dynamic Range), processes the image to improve its quality
- High Definition without buffering, so as not to burden the processor of the PC/Mac
- Noise Reduction Processing, removes annoying background noise for a crystal clear audio
- Higher Sound Pickup Quality, for a faithful rendering of the voice pitch
- Auto Light Dimming, also ideal for poorly lit environments
- Livestream Webcam, perfect for your live social media

Packaging and codes

Webcam - code **C1522**

BICYCLE AND MOTORCYCLE HANDLEBAR SMARTPHONE HOLDERS

Midland smartphone mounts are designed to be ergonomically functional even when wearing motorcycle gloves. Manufacturing precision ensures a secure grip even on rough terrain or off-road, keeping the smartphone always firmly on the handlebar.

MH-PRO NV C1568

Bicycle and motorcycle universal mount for smartphones in premium aluminium, with vibration reduction system.
Telephone housing: up to 7.2"
Waterproof IP68.
Handlebar mount: Ø 12-32mm.
Support for fixing to rear-view mirror included. Fitted with Five hook system™.



MH-Pro WC C1487

Aluminium universal mount.
Telephone housing: up to 6.5".
Waterproof IP65.
Handlebar mount: Ø 12-24mm.
Support for fixing to rear-view mirror included.
Fitted with Four hook system™.



NEW

MH-NV C1584

Universal support in polyamide, with vibration reduction system.
Waterproof IP68.
Telephone housing: up to 7.2".
Handlebar mount: Ø 12-32mm.
Fitted with Four hook system™.



MH-Pro USB C1490

Aluminium universal mount.
Waterproof IP65.
Telephone housing: up to 6.2".
Silicone safety grille included.
USB charging socket.
Handlebar mount: Ø 22-32mm



MH-Pro C1489

Aluminium universal mount.
Telephone housing: up to 6.2".
Silicone safety grille included.
Handlebar mount: Ø 22-32mm.



OVERVIEW TABLES



Model	Wild Guardian Wi-Fi	Wild Guardian
Resolution	4K 10fps / 2.7K 20fps	1920x1080 30fps
Sensor	CMOS	CMOS
Aspect Ratio	16:9	16:9
Format	AVI	AVI
Lens	4 elements	4 elements
Lens angle	90°	88°
Sd Card	Up to 128GB	Up to 128GB
Battery	8xAA not included	4xAA not included
Wi-Fi	Yes	-
Photo	24 Mp	-
Tripod mount	Yes	Yes
Weight	260 g	185 g
Dimensions WxHxD	135x100x70 mm	110x90x65 mm
Operating systems	Windows 10, Vista 7&8, Mac OSX 10.4+	



Model	Bike Guardian Pro	Bike Guardian	Wireless RV Cam
Resolution	2K 30fps	1920x1080p (27fps)	480xRGBx272
Sensor	Sony	Sony 2 MP	CMOS CON IR
Aspect Ratio	16:9	16:9	4:3
Format	MOV	MOV	NTSC
Lens	-	-	-
Lens angle	170°	120°	120°
Sd Card	Up to 256GB	64 GB (Classe 10)	-
Battery	1200mAh	680mAh up to 120'	2160 mAh
Wi-Fi	Yes	-	-
Photo	24 Mp	16 Mp	-
Tripod mount	Yes	Yes	Suction cup - magnetic
Weight	105 g	78 g	Monitor 254 g/Video camera 233 g
Dimensions WxHxD	97mm Ø 32mm	86 mm Ø27 mm	Monitor 125x85x18 mm Video camera 76x100x50 mm
Operating systems	Windows 10, Vista 7&8, Mac OSX 10.4+		-

OVERVIEW TABLES



Model	Truck Guardian Pro		Truck Guardian Wired	
	Monitor	Video camera	Monitor	Video camera
Resolution	1024xRGBx600	1280x720	1024xRGBx600	1280x720
Sensor	-	CMOS	-	Sony
Aspect Ratio	16:9	16:9	16:9	16:9
Format	-	-	-	-
Lens	-	-	-	-
Lens angle	-	120°	-	100°
Sd Card	128 GB	-	-	-
Battery	-	-	-	-
Wi-Fi	2.4 GHz encrypted transmission	2.4 GHz encrypted transmission	-	-
Tripod mount	Support bracket	Support bracket	Yes	Support bracket
Weight	430 g	500 g	408 g	340 g
Dimensions WxHxD	180x125x25 mm	85x50x40 mm	192x115x25 mm	70x45x60 mm
Operating systems	Windows 10, Vista 7&8, Mac OSX 10.4+		-	-



Model	H9 Pro	H5 Pro	H3+	W199	Follow U
Resolution	4K@30 2.7K@30-1080p@60 720p @ 120/60	4K@30 2.7K@30-1080p @60 720p@120/60	1080p@30 720p @60 480p@60	1080p	1080p
Sensor	20 Mp	16 Mp	16Mp	2 Mp	SONIX 2872
Aspect Ratio	16:9	16:9	16:9	16:9	16:9
Format	MOV	MOV	AVI	-	-
Lens	6 elements	5 elements	1 elemento	4	-
Lens angle	100°-110°-130°	120°	120°	76°	120° - 360°
Sd Card	Up to 256 GB	Up to 128 GB	Up to 128 GB	No	No
Battery	1050 mAh, up to 120'	Li-Ion 1050 mAh, up to 120'	Li-Ion 900mAh, up to 110' in HD	No	No
Wi-Fi	Yes	Yes	Yes	No	No
Photo	20 Mp	16 Mp		Yes	Yes
Tripod mount	Yes	Yes	No	No	Yes
Weight	65 g	65 g	52 g	140 g	206 g
Dimensions WxHxD	59x41x24 mm	59x41x24 mm	59.3x29.3x41.1 mm	7x2.5x2 mm	65x65.5x86.5mm
Operating systems	Windows 10, Vista 7&8, Mac OSX 10.4+				

Discover the video



POWERBANK

 MIDLAND®

ER300

The powerful multifunctional emergency powerbank.

AM/FM Radio



Dynamo recharge



Charge the device with USB port



SOLAR PANEL



ER300 is a **powerful powerbank** capable of recharging portable devices and an **emergency device** equipped with an AM/FM receiver, designed for emergency situations, disasters and safety in which keeping in touch is essential. **ER300** is a versatile solution also for everyday use, for outdoor activities, camping or in leisure time. **Rechargeable via dynamo, solar panel, batteries and USB socket. With ultrasonic call for dogs, torch.**

Frequency: 531-1629 kHz (AM)
87.5-108 MHz (FM)

Colour: Red/Black

Features







- Recharge: dynamo, solar panel, Li-Ion integrated battery pack or AA batteries, via mini-USB socket
- It charges external electronic devices with USB port
- Power bank with long life battery Li-Ion 2600 mAh, lasting up to 25 hours of normal use
- It also works with 6 AA batteries
- Flashlight with Cree® led
- SOS Morse code flashlight beacon
- Ultrasonic dog whistle useful for rescue teams
- AM/FM radio
- Digital clock
- Headphone jack
- Telescopic antenna
- Wide, bright LCD with backlight

Packaging and codes

Radio, 2600 mAh Li-Ion battery pack, USB/micro USB cable

code C1173

* Cree® is a registered trademark of Cree Inc.

 AM/FM RADIO	 POWER SOURCE DYNAMO CRANK	 POWER SOURCE SOLAR PANEL	 LED FLASHLIGHT	 CHARGE THE DEVICE WITH USB	 BATTERY UP TO 25 HOURS
 DOG WHISTLE FOR RESCUE TEAMS					

ER250 BT

Power bank, radio and Bluetooth speaker: essential in emergencies, perfect for adventure.

NEW



Charging via dynamo/via USB cable



AM/FM radio

SOLAR PANEL



 Bluetooth®

ER250 BT is a compact multifunctional device designed by Midland which has been optimized to tackle emergency situations and deliver enhanced safety for your adventures and leisure activities. In any light or energy condition, the solar panel, crank dynamo and USB cable allow recharging of the high-efficiency Li-Ion battery, guaranteeing up to 25 hours of life under normal use conditions and the possibility of recharging other electronic devices via the USB port. The AM/FM radio with telescopic antenna allows you to stay connected and informed at all times, an indispensable condition in the most critical moments, the same ones when the 130L Cree® LED flashlight with SOS function and Morse code can make the difference.

The stand-out innovation of the **ER250 BT** is the inclusion of Bluetooth technology that lets you enjoy audio and music from smartphones or tablets in superior audio quality.

A richer and more full-bodied sound that also saves the batteries of connected devices, a precious resource in outdoor life situations.

Frequency: 531-1629 kHz (AM)
87.5-108 MHz (FM)

Colour: Red and black

Features

- Bluetooth power: 6dBm
- Sound power: >300mW
- Weight (battery not included): 327g
- Rechargeable with dynamo, solar panel or USB cable
- Bluetooth connection to phone or portable devices
- High-efficiency 2600mAh Li-Ion rechargeable battery
- Flashlight with Cree®* led
- Morse code SOS function
- Charging of external electronic devices
- AM/FM radio
- Digital clock
- Telescopic antenna
- Audio jack socket: 3.5mm stereo

Packaging and codes

Radio, 2600 mAh Li-Ion battery pack, USB cable
code **C1587**

* Cree® is a registered trademark of Cree Inc.

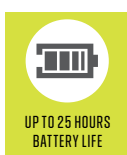
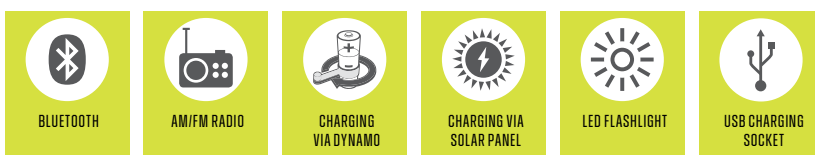

ER200

Compact outdoor powerbank.



AM/FM radio



Charge the device with USB port

SOLAR PANEL



ER200 is a compact power bank, perfect for outdoor use (camping, beach, park, mountain, etc.) and in an emergency.

Small in size, ER200 is an excellent companion for every hiker, able to recharge portable devices. It is also equipped with an AM/FM receiver and LED torch.

Multiple sustainable recharging sources: dynamo, solar panel and rechargeable batteries

Frequency: 531-1629 kHz (AM)
87.5-108 MHz (FM)

Colour: Red/Black

Features

- Power sources: dynamo crank, solar panel or USB cable
- Long life battery Li-Ion 2600 mAh, lasting up to 25 hours of normal use
- SOS Morse code flashlight beacon
- Flashlight with Cree® led 130L
- It charges external electronic devices with USB port
- AM/FM radio
- Digital clock
- Headphone jack
- Telescopic antenna
- LCD display

Packaging and codes

Radio, 2600 mAh Li-Ion battery pack, USB cable
code C1469

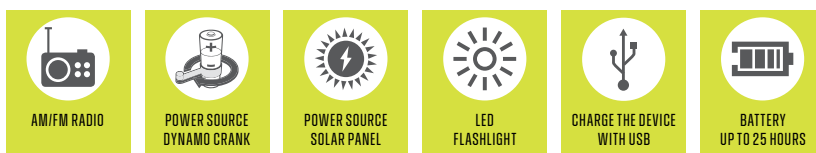

* Cree® is a registered trademark of Cree Inc.

MIDLAND MOTORCYCLE INTERCOMS

Since 2005, Midland has specialized in motorcycle communication products.

Over the course of these 15 years Midland has created an R&D laboratory, within which professional engineers dedicate themselves daily to the development of technologically advanced products.

After years of constant studies and tests, the audio of Midland intercoms is the most advanced ever, thanks to strict controls on "Quality", the signature that has distinguished the company for over 60 years.

Your adventures on the road

Midland intercoms offer you maximum communication performance, to reach the fourth dimension of travel and give you a unique experience. Share emotions and excitement on the road and get 360-degrees adventures.

Top audio experience

Thanks to the partnership with RCF, Midland intercoms are able to provide high-performance audio even in the most extreme conditions, reducing external noises and allowing you to make the most of the phone call and music playback functions.

Always connected with your friends

Midland intercoms are easy to use and extremely versatile. The Bluetooth and Mesh technologies allow group connections of up to 10 motorcyclists without connection limits with intercoms of other brands or pairing with third-party devices.

Below is a selection of products, discover the whole range at midlandeurope.com.

BTX2 PRO S

Group communication with dual Bluetooth chipset.



BTX2 Pro S is the first mid-range intercom with dual Bluetooth chipset technology: 8 people (4 motorcycles), including riders and passengers connected in Conference mode, up to 6 people in One-to-One mode. All this in Full Duplex mode, with digital quality, DSP noise suppression system and AGC (a system you can disable and adjust) to control the volume automatically according to the background noise.

Compatible with integrated connectivity and control systems adopted by the major motorcycle manufacturers (BMW, KTM, Honda, Ducati...).

Features

- Bluetooth® dual chipset
- Universal Intercom for pairing with intercoms of other brands
- Music Share
- Web Radio (using the Midland Connect app)
- Voice status messages, Vox
- Connects 2 mobile phones
- Stereo Background
- Fixing system with bi-adhesive tape and clamp
- Waterproof IPX6

Packaging and codes

Device, boom and wired microphones, slide-in clamp and bi-adhesive coupling system for all helmet types, audio kit with Hi-Fi speakers, Micro USB charging cable.

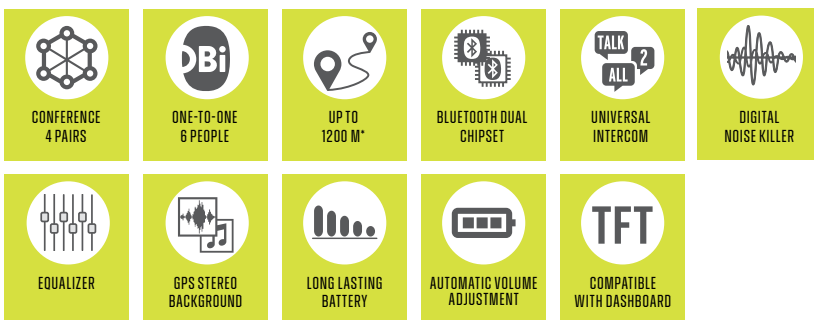

BTX1 PRO

Driver-passenger communication.



BTX1 Pro is the perfect system for rider-passenger communication.

Reliable, easy to use, with a very long battery life. The perfect companion for all your trips.

All in Full Duplex, with digital quality and DSP system for noise suppression. Moreover, the AGC (a system you can disable and adjust) allows controlling the volume automatically according to the background noise.

Compatible with integrated connectivity and control systems adopted by the major motorcycle manufacturers (BMW, KTM, Honda, Ducati...).

Features

- Bluetooth® chipset
- Universal Intercom
- Music Share
- Web Radio (using the Midland Connect app)
- Voice status messages, Vox
- Connects 2 mobile phones
- Fixing system with bi-adhesive tape
- Waterproof IPX6

Packaging and codes

Device, boom and wired microphones, slide-in bi-adhesive coupling system for all helmet types, audio kit with Hi-Fi speakers, Micro USB charging cable.

BTGO UNI

The invisible system for those travelling alone or with a passenger.

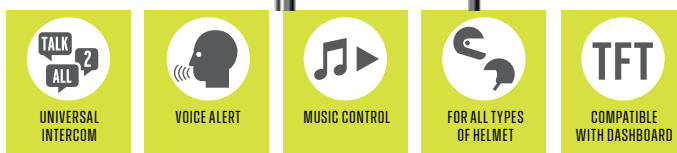

BT Go Uni is the all-in-one system for the single user or driver-passenger.

With BTGO Uni you can listen/manage music in stereo mode, make and receive calls and talk to the passenger. All in Full Duplex mode, with digital quality and DSP system for noise suppression.

Compatible with integrated connectivity and control systems adopted by the major motorcycle manufacturers (BMW, KTM, Honda, Ducati...).

Features

- Bluetooth® chipset
- 2 function keys
- For all types of helmet
- DSP Noise filter
- Voice status messages
- Power Audio Stereo Sound/AVRCP Music control
- Velcro pad to fix speakers and bi-adhesive tape for push-buttons
- Waterproof

Packaging and codes

Intercom, wired microphone for full-face helmets, boom microphone for modular helmets, type C USB charging cable, microphone spare sponge, velcro pad to fix speakers and microphones.
code C1310.01

MIDLAND GROUP

USA
Midland Radio Corporation
Kansas City
midlandusa.com

Italy
Midland Europe srl
Reggio Emilia
midlandeuropa.com

Germany
Alan Electronics
Dreieich
Trittau
info@alan-electronics.de
alan-electronics.de

Spain
Alan Communications SA
Barcelona
info@midland.es
es.midlandeuropa.com

France
Alan France
Vitrolles
(Provence-Alpes-Côte d'Azur)
infos@alanfrance.fr
alan-midland.fr

Bulgaria
Alan Telecommunication
Sofia
alan.bulgaria@me.com
midlandeuropa.com

Poland
Alan Telekomunikacja
Warsaw
info@alan.pl
alan.pl

Romania
Fomco Trade srl
Judetul Mures
office@fomco.ro
fomcoshop.ro

Ukraine
Cbitaxo
Rivne
office@taho.com.ua
taho.com.ua

Sweden
Tura Scandinavia AB
Kungsbacka
info@turascandinavia.com
turascandinavia.com

Russia
Alan-Sviaz
Moscow
info@midland.ru
midland.ru

Greece
Cobra Center Ltd
Athens
techdep@cobra-center.gr
cobra-center.gr

Australia
Autobacs Australia PTY Ltd
Sydney
info@autobacs.com.au
autobacs.com.au

Colombia
InduGuimm Sas DbA EnMoto
Medellin
info@enmoto.co
enmoto.co

Japan
Links Of Japan
Osaka
info@midlandradio.jp
midlandradio.jp

India
PowerSports International
Chennai
contact@powersports.in
powersports.in

Israel
Shchori Cellular Communication
Tel-Aviv
info@midland.co.il
midland.co.il

Thailand
Panda Rider Co., Ltd
Bangkok
sales@pandarider.com
pandarider.com

Turkey
Midland Turkey
Istanbul
ocagman@midlandeuropa.com
midlandturkey.com

Venezuela
Distribuidora CarAvila C.A.
Filas de Mariche
cchaves@car-avila.com
car-avila.com

Certifications

ISO 9001 2015

for the design, production and installation of telecommunication systems and equipment for industrial, military, civil, marine and consumer use.



REG. N.1484-A
UNI EN ISO 9001:2015

ANITEC-ASSINFORM: MIDLAND EUROPE

Midland Europe is part of the ANIE Federation research and innovation commission, a member of Confindustria and represents the electro-technical and electronic businesses operating in Italy.



Anitec-Assinform

Member of Confindustria and Confindustria Digitale
Italian Association of Information and
Communication Technology Companies

Warranty

All our products are covered by a 24-month warranty, as long as they are sent to our **Technical Service Centres** together with the tax receipt. Contact our **Authorised Retailer** who will tell you where the nearest Service Centre is located. **NB:** we accept the return of goods upon two conditions: the agreed authorization from **Sales Dept.** (+39 0522 509411) or **Customer Technical Support Dept.** (+39 0522 509535) or **Intercoms** (+39 0522 509446), and if costs of shipments are covered by sender.

The authorization is mandatory and if lacking, products will be immediately returned to the sender.

Midland, a brand born in 1959 in a small factory in Kansas City, is today the world leader in the radiocommunication and consumer electronics sector.

A group that today has over **15 European and non-European subsidiaries**, between branches and strategic partners, and a distribution in **over 90 countries**, under the guidance of the **Italian Headquarters**.

Reggio Emilia is the headquarters of Research and Development that carries out the company mission daily and with great commitment.

“Create a world where communicating is simple, fun and available to everybody.”

Design and manufacture with passion products of quality, technologically innovative and that respond to the real need of all of us: to communicate.

***A SUCCESS THAT HAS LASTED
FOR OVER 60 YEARS.***

MIDLAND[®]
MOVING COMMUNICATION

MIDLAND[®]

MOVING COMMUNICATION

Download
the catalog



midlandeuropa.com
info@midlandeuropa.com
Midland World

