



**Thank You for Shopping at Radioddity!**  
FIND TUTORIALS, SUPPORT AND MORE



<https://www.radioddity.com/>



<https://www.facebook.com/radioddity>



<https://www.youtube.com/c/Radioddityradio>

Sain3 LLC  
251 Little Falls Drive Wilmington, New Castle  
DE, 19808  
E-mail: [support@radioddity.com](mailto:support@radioddity.com)



Radioddity

# **CB-5000**

## **AM/FM/SSB CB RADIO**



# Instruction Manual



[www.radioddity.com](http://www.radioddity.com)



[support@radioddity.com](mailto:support@radioddity.com)

## **WARNING**

**In order to comply with RF exposure requirements for mobile transmitting devices, a minimum distance of 20cm must be maintained between the antenna and all persons.**

# CONTENTS

|   |           |
|---|-----------|
| <b>1. FUNCTIONS &amp; FEATURES</b> .....                    | <b>1</b>  |
| <b>2. ACCESSORIES</b> .....                                 | <b>2</b>  |
| 2.1 Standard Accessories .....                              | 2         |
| 2.2 Optional Accessories .....                              | 2         |
| <b>3. INSTALLATION</b> .....                                | <b>3</b>  |
| 3.1 Microphone Connection .....                             | 3         |
| 3.2 Antenna Connection .....                                | 3         |
| 3.3 Power Connection .....                                  | 4         |
| 3.4 Fuse Replacement .....                                  | 4         |
| 3.5 Install Microphone Hanger .....                         | 5         |
| 3.6 Install External Speaker .....                          | 5         |
| <b>4. GETTING ACQUAINTED</b> .....                          | <b>6</b>  |
| 4.1 Front Panel .....                                       | 6         |
| 4.2 Rear Panel .....  | 6         |
| 4.3 Microphone .....  | 7         |
| <b>5. BUTTON FUNCTION INSTRUCTIONS</b> .....                | <b>8</b>  |
| 5.1 Power Key .....   | 8         |
| 5.2 Volume Control Knob .....                               | 8         |
| 5.3 Key Locking Function .....                              | 8         |
| 5.4 Modulation Mode Selection .....                         | 8         |
| 5.5 Weather Channel Function .....                          | 8         |
| 5.6 SQ Level Adjustment .....                               | 8         |
| 5.7 ASQ Level Adjustment .....                              | 9         |
| 5.8 RF Gain Adjustment .....                                | 9         |
| 5.9 Emergency Channel Call .....                            | 9         |
| 5.10 Memory Channel .....                                   | 9         |
| 5.11 Store Memory Channel .....                             | 9         |
| 5.12 Delete Memory Channel .....                            | 9         |
| 5.13 Channel Selection .....                                | 10        |
| 5.14 Scan Function .....                                    | 10        |
| 5.15 Dual Watch Function .....                              | 10        |
| 5.16 Noise Reduction (NRC) Function .....                   | 10        |
| 5.17 Hands Free VOX Function .....                          | 10        |
| 5.18 SSB Frequency Fine Tuning .....                        | 10        |
| <b>6. MENU SETTING</b> .....                                | <b>11</b> |
| 6.1 Function Menu Setting .....                             | 11        |
| 6.2 Public Menu Setting .....                               | 14        |
| 6.3 Channel Menu Setting .....                              | 15        |
| 6.4 DTMF Menu Setting .....                                 | 16        |
| 6.5 Microphone Menu Setting .....                           | 17        |
| 6.6 Time Setting .....                                      | 17        |
| 6.7 Weather Channel Menu Setting (optional functions) ..... | 18        |
| 6.8 Radio version check .....                               | 19        |
| <b>7. SPECIFICATIONS</b> .....                              | <b>20</b> |

## 1. FUNCTIONS & FEATURES

- TFT LCD display
- 12/24V voltage support
- The aluminium body ensures reliable heat radiation
- CTCSS/DCS encoding and decoding function
- USB, LSB, CW, AM, FM, PA modes
- Flexible function menu
- DTMF function
- SQ and ASQ functions
- RF gain function
- Scanning function
- Dual watch function
- Programmable RB function
- Emergency channel function
- Storage channel function
- NB/ANL function
- HI-CUT function
- ECHO function
- VOX function
- NRC (noise reduction) function
- Power supply voltage protection function
- Timeout timer (TOT) function
- Backlight brightness adjustment
- Keyboard lock function
- Weather channel function

## 2. ACCESSORIES

### 2.1 Standard Accessories



Radio



Microphone

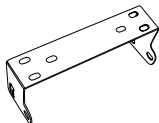

Install bracket



Screws



Pads



Adjusting screws

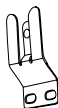

Microphone Hanger



non-slip mat



Fuse(10A 250V)

### 2.2 Optional Accessories



PC cable



8 ohm speaker

## 3. INSTALLATION

Choose a ideal location to install the radio.

1. Mark the location for screws to secure the install bracket.
2. Fix the bracket with screws.
3. Fix radio base into install bracket and lock with adjusting screws.

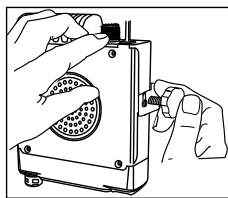
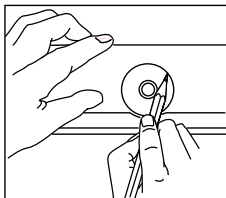

### 3.1 Microphone Connection

1. Plug microphone connector into jack.
2. Secure the dustproof cover for microphone connector.



### 3.2 Antenna Connection

 **NOTE** » Never press PTT before installing the antenna. damage to the radio may occur.

1. Screw on the antenna into antenna jack.
  2. To make full use of this radio, it is necessary to locate the antenna in a well grounded place, and ensure it is tuned with a with a low SWR.
- \* Please enquire at your local dealer regarding choosing and installing a suitable antenna.

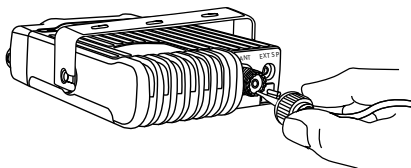

### 3.3 Power Connection

This radio adopt 13.2V power supply.

Connect the red wire to the positive terminal of the battery, and the black wire to the negative terminal of the battery.

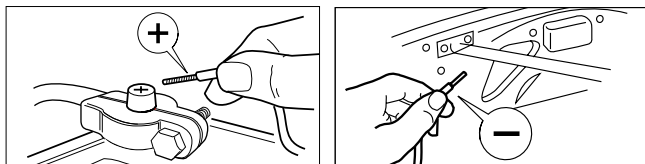

### 3.4 Fuse Replacement

This radio adopt 10A, 250V fuse

1. Open the fuse holder

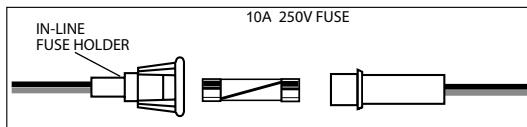

2. Replace the fuse and screw on the holder.

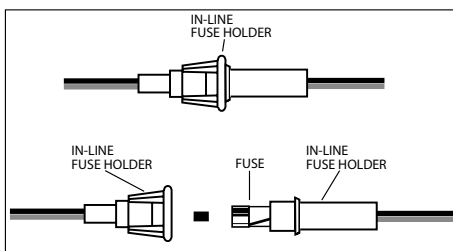

### 3.5 Install Microphone Hanger

1. Choose ideal location and mark for screw points.
2. Fix the hanger using the screws shown in the accessory list.

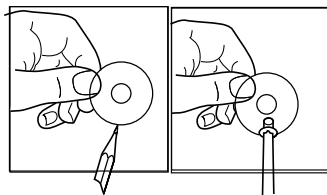

### 3.6 Install External Speaker (Optional)

This radio can adopt a 4-8 ohm, 4W external speaker.

1. Install the external speaker in idea location.
2. Plug in the speaker connector into jack.

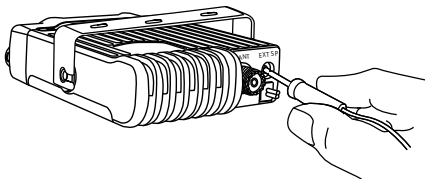

## 4. GETTING ACQUAINTED

### 4.1 Front Panel

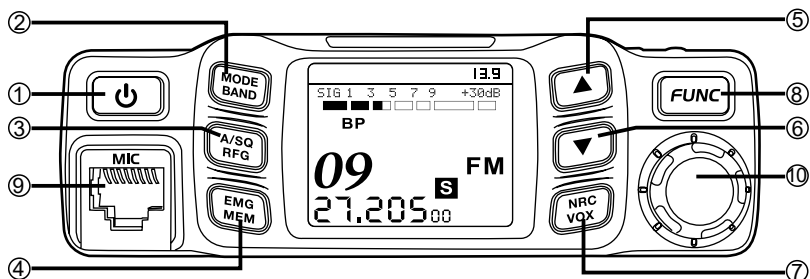

| NO. | Key | Functions                                     |
|-----|-----|---|
| 1   |     | Power On/Off/Mute                             |
| 2   |     | Modulation mode / Band switch                 |
| 3   |     | SQ/ASQ squelch, RF Gain level setting         |
| 4   |     | EMG channel / Memory storage channel          |
| 5   |     | Channel up                                    |
| 6   |     | Channel down                                  |
| 7   |     | NRC noise reduction function / VOX hands-free |
| 8   |     | Function Menu key                             |
| 9   | MIC | Microphone Jack                               |
| 10  |     | VOL Switch/Push key/ Key lock                 |

### 4.2 Rear Panel

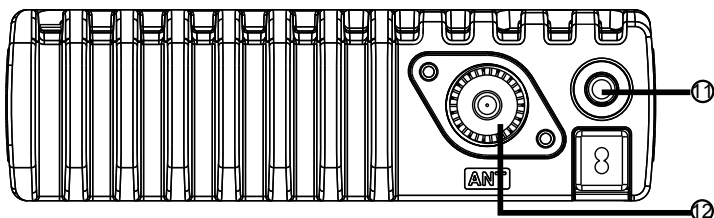

| NO. | Functions             |
|-----|-----------------------|
| 11  | External Speaker Jack |
| 12  | Antenna Jack          |

## 4.3 Microphone

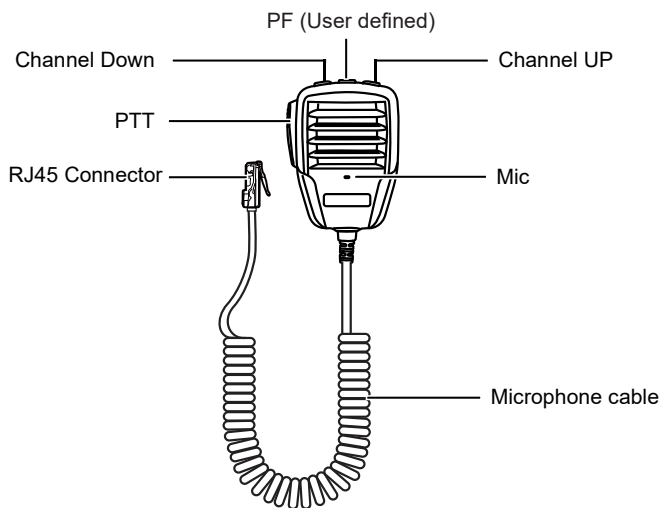



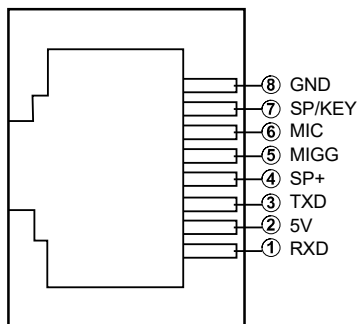

### Microphone pin-out



## 5. BUTTON FUNCTION INSTRUCTIONS

### 5.1 Power Key

1. Turn on the radio: Short press the  key, to switch the radio ON, the radio may emit a beep depend on if the prompt beep is enabled , and the screen will display startup logo, then enter standby status.
2. Turn off the radio: Long press the  key until the screen displays the startup logo, release the key, the display will off and radio power off.
3. Quick mute: In standby status, Short press the  key, the screen displays " **Speaker Mute On** " , and the **MUTE** icon is displayed in the upper left corner of the the screen, the radio enters the mute state; Short press the  key again, and " **Speaker Mute Off** " will be displayed on the screen. and the **MUTE** icon will disappear,

### 5.2 Volume Control Knob

When the radio is turned on, turning **VOL** clockwise will increase the Volume level. Turning **VOL** anti-clockwise will reduce the Volume level. Adjust the volume during communication to get suitable level. (NOTE: See the "CH/VOL Swap" menu item to swap this function to the Up/Down keys.)

### 5.3 Key Locking Function

Press and hold the [PUSH] key to turn on key lock function, the LCD will display key lock icon. Press and hold the [PUSH] key again to unlock the key.



 » *When this function is turned on, only the [PTT] button is valid.*

NOTE

### 5.4 Modulation Mode Selection

Short press the  key to choose the modulation mode FM → AM → USB → LSB → PA → CW.



### 5.5 Weather Channel Function

Long press the  key to enter weather channel , long press the  key again to exit weather channel.



### 5.6 Squelch SQ Level Adjustment

1. Short press the  key to display the current SQ level on the screen, and rotate the channel knob to adjust the squelch level;
2. Press any key or wait for 3 seconds to automatically save and exit the function settings.

## 5.7 ASQ Level Adjustment



1. Long press the  key to switch to the ASQ function, and the screen will display the AQ character;
2. Short press the  key to display the current ASQ level on the screen, and rotate the channel knob to adjust the squelch level;
3. Press any key or wait for 3 seconds to automatically save and exit the function settings.

## 5.8 RF Gain Adjustment





1. Short press the + key to enter the RF gain adjustment menu, and the screen will display Rx Gain Level: **xxx**;
2. Rotate the channel knob to adjust the RF gain level;
3. Press any key or wait for 3 seconds to automatically save and exit the function settings.

## 5.9 Emergency Channel

Short press the  key to enter emergency channel, the screen will display "EMG".

1. Short press the  key to choose CH9;
2. Short press the  key again to choose CH19 ;
3. Short press the  key again return to last normal channel.

## 5.10 Memory Channel

1. Press the  key+ key to enter the memory channel mode, rotate the channel switch to choose memory channel, total of 16 channels;
2. Press the  key+ key again to exit the memory channel mode.

## 5.11 Store memory Channel:

Select the channel which want to be stored, long press the [MEM] key to enter the memory channel mode, rotate the channel switch to select the channel number to be stored, long press the  key until the screen displays the channel that has been stored, and the storage is complete.

-  » 1. When the screen flashes red MEM, it indicates that the current storage channel has stored data:
- » 2. When the screen flashes blue MEM, it indicates that there is no data stored in the current storage channel:

## 5.12 Delete Memory Channel

Select the channel which want to be deleted, press and hold the  key for 3 seconds, and the radio will emit a "beep" prompt sound. The current storage channel has been deleted.

### 5.13 Channel Selection

1. Short press the [▲]/[▼] or the [UP]/[DN] keys on the microphone to switch the working channel.
2. Long press the [▲]/[▼] or [UP]/[DN] keys on the microphone to quickly switch between working channels.

### 5.14 Scan Function

1. Press the **FUNC** key+[▲] key to activate the scan function, and the screen will display the "S" icon;
2. Short press the [▲]/[▼] or [UP]/[DN] keys on the microphone while scanning to change the scanning direction;
3. Press the **FUNC** key+[▲] key again to exit the scanning mode.

### 5.15 Dual Watch Function

1. Select the dual watch channel, press the **FUNC** key+[▼] key to start the dual watch function, and the screen will display the "DW" icon;
2. Press the **FUNC** key+[▼] key to exit the dual standby state.

### 5.16 Noise Reduction (NRC) Function

1. Short press the NRC button to turn on or off the NRC function, and the LCD will display the NRC icon;
2. Long press the NRC button for 3 seconds to enter to the NRC menu.

### 5.17 Hands Free VOX Function

Press the **FUNC** key+**NRC VOX** key, turn on or of VOX function, LCD displays VOX icon.

### 5.18 SSB Frequency Fine Tuning

When the radio is in the receiving state, push the channel switch to enter the SSB frequency fine adjustment function. Rotate the channel switch to adjust the USB/LSB receiving frequency. Rotate clockwise to increase the frequency, and counterclockwise to decrease the frequency.

## 6. MENU SETTING

### 6.1 Function Menu Setting

1. Long press the **FUNC** key to enter the MENU list;
2. Short press the **[▲]/[▼]** keys or rotate the volume knob to move the cursor, and press the **[PUSH]** key to enter the Functions menu;
3. Short press the **[▲]/[▼]** keys or rotate the volume knob to select the desired function option, and press the **[PUSH]** key to enter parameter settings;
4. Press the Back (EMG) button to save and return to the previous menu step by step.

| NO. | LCD display            | Setting details   |
|-----|------------------------|---|
| 1   | <b>Key Beep</b>        | 1-5, OFF, Total 6 levels available.<br><b>Default:</b> 03.  |
| 2   | <b>CH/VOL SWAP</b>     | Channel/volume Knob setting<br><b>VOL:</b> Volume Adjustment<br><b>CH:</b> Channel adjustment<br><b>Default:</b> VOL    |
| 3   | <b>Microphone Gain</b> | 1-45, Total 45 levels of Microphone Gain available.<br><b>Default:</b> 33.  |
| 4   | <b>Microphone Type</b> | <b>Electret:</b> Electret Microphone<br><b>Dynamic:</b> Dynamic Microphone<br><b>Default:</b> Electret                  |
| 5   | <b>ECHO Volume</b>     | 1-32, Total 32 levels available;<br><b>Default:</b> 28  |
| 6   | <b>ECHO Delay Time</b> | 1-32, Total 32 levels available;<br><b>Default:</b> 28  |
| 7   | <b>Time Out Timer</b>  | 1-600s, OFF, Total of 10 minutes available;<br><b>Default:</b> 180s   |
| 8   | <b>SWR Warning</b>     | Set the SWR Protection function, 1.0-20.0 available<br>OFF: disable the SWR Protection function<br><b>Default:</b> 20.0 |
| 9   | <b>Scan Type</b>       | <b>Squelch:</b> Squelch based scan function;<br><b>Time:</b> Time based scan function;<br><b>Default:</b> Squelch       |

| NO. | LCD display            | Setting details  |
|-----|------------------------|--|
| 10  | <b>Dimmer</b>          | 1-5, 5 backlight dimmer levels available;<br><b>Off:</b> Turn off the backlight;<br><b>Default:</b> 5                      |
| 11  | <b>DW Setting</b>      | Set the Dual Watch channel, mode and band:   |
| 12  | <b>EMG 1 Setting</b>   | Set Emergency Channel 1 and its mode.  |
| 13  | <b>EMG 2 Setting</b>   | Set Emergency Channel 2 and its mode.  |
| 14  | <b>ASQ Setting</b>     | <b>01-09:</b> Total of 9 Automatic Squelch levels;<br><b>OFF:</b> Turn off ASQ<br><b>Default:</b> 05.                      |
| 15  | <b>VOX Sensitivity</b> | 01-09, Total of 9 VOX sensitivity levels. <b>OFF:</b> turns off the VOX function;<br><b>Default:</b> 03                    |
| 16  | <b>VOX Delay Time</b>  | 01-09, Total of 9 VOX Delay Time levels;<br><b>Default:</b> 03   |
| 17  | <b>RX NRC</b>          | <b>01-05:</b> Total of 5 levels for RX noise reduction;<br><b>OFF:</b> Turn off RX noise reduction;<br><b>Default:</b> OFF |
| 18  | <b>TX NRC</b>          | <b>01-05:</b> Total of 5 levels for TX noise reduction;<br><b>OFF:</b> Turn off TX noise reduction;<br><b>Default:</b> OFF |
| 19  | <b>SSB TX Audio</b>    | <b>HI-4K:</b> 4K audio response;<br><b>LO-3K:</b> 3K audio response;<br><b>Default:</b> HI-4K                              |
| 20  | <b>CW Beep</b>         | <b>01-63:</b> Adjusts the CW Sidetone level (volume);<br><b>OFF:</b> CW Sidetone disabled;<br><b>Default:</b> 31           |
| 21  | <b>CW Freq</b>         | <b>300Hz-3KHz:</b> This menu is to select CW Sidetone frequency;<br>The frequency step is 10Hz;<br><b>Default:</b> 1050Hz  |
| 22  | <b>CW RX Setting</b>   | <b>USB:</b> select USB for CW RX;<br><b>LSB:</b> select LSB for CW RX;<br><b>Default:</b> USB                              |

| NO. | LCD display                 | Setting details  |
|-----|-----------------------------|--|
| 23  | <b>CW Delay Time</b>        | <b>10-1000MS:</b> TX delay (CW break-in);<br><b>OFF:</b> No TX delay;<br><b>Default:</b> 500MS   |
| 24  | <b>CW Shift</b>             | <b>ON:</b> CW RX Shift ON (RX Shift = +/- "CW.FREQ");<br><b>OFF:</b> CW RX Shift OFF;<br><b>Default:</b> OFF   |
| 25  | <b>S-Meter Response</b>     | <b>SLOW:</b> AGC SLOW response;<br><b>FAST:</b> AGC FAST response;<br><b>Default:</b> SLOW   |
| 26  | <b>Talkback</b>             | 1-32, OFF, Total 33 levels available;<br><b>Default:</b> OFF (Disable Talkback function)   |
| 27  | <b>Voltage Protection</b>   | <b>OFF:</b> Disable the Voltage Protection function;<br><b>ON:</b> Enable the Voltage Protection function;<br><b>Default:</b> ON   |
| 28  | <b>TX DRC</b>               | <b>OFF:</b> Turn off Dynamic Range Compression function;<br><b>ON:</b> Turn on Dynamic Range Compression function;<br><b>Default:</b> ON   |
| 29  | <b>Clarifier</b>            | <b>OFF:</b> Disable clarifier adjustment;<br><b>RX:</b> Enable RX frequency adjustment;<br><b>TX:</b> Enable TX frequency adjustment<br><b>RX+TX:</b> Enable both RX and TX frequency adjustment<br><b>Default:</b> RX |
| 30  | <b>Clarifier Freq Range</b> | <b>500Hz:</b> adjustable range $\pm 500\text{Hz}$ ;<br><b>5KHz:</b> adjustable range $\pm 5\text{KHz}$ ;<br><b>Default:</b> 500Hz  |
| 31  | <b>Factory Reset</b>        | <b>MENU:</b> Settings/Functions reset to defaults;<br><b>ALL:</b> Channels and Settings/Functions reset to defaults;<br><b>Default:</b> ALL  |

## 6.2 Public Menu Setting

1. Long press the **FUNC** key to enter the MENU selection list;
2. Short press the [**▲**]/[**▼**] keys or rotate the volume knob to move the cursor, and press the [PUSH] key to enter the PD Para menu;
3. Short press the [**▲**]/[**▼**] keys or rotate the volume knob to select the desired function option, and press the [PUSH] key to enter parameter settings;
4. Press the Back(EMG) button to save and return to the previous menu step by step.

| NO. | LCD display | Functional Description  |
|-----|-------------|---|
| 1   | HI-CUT      | <b>OFF:</b> Disable HI-CUT function;<br><b>ON:</b> Enable HI-CUT function;<br><b>Default:</b> OFF.  |
| 2   | NB/ANL      | <b>OFF:</b> Disable NB/ANL function;<br><b>NB:</b> Enable NB function;<br><b>ANL:</b> Enable ANL function;<br><b>NB/ANL:</b> Enable NB/ANL function;<br><b>Default:</b> OFF.  |
| 3   | ECHO        | <b>OFF:</b> Disable ECHO function;<br><b>ON:</b> Enable ECHO function;<br><b>Default:</b> OFF   |
| 4   | Roger Beep  | OFF- 5, Total 6 options.<br><b>Default:</b> OFF, (RB Disabled)  |
| 5   | DTMF BOT    | <b>BOT:</b> Press PTT to send DTMF encode;<br><i><u>Note: If the M1-M16 memory storage has no PTT ID's set, the DTMF function will be defaulted to OFF. DTMF groups can only be selected once they have been programmed.</u></i>      |
| 6   | DTMF EOT    | <b>EOT:</b> Release PTT to send DTMF encode;<br><i><u>Note: If the M1-M16 memory storage has no PTT ID's set, the DTMF function will be defaulted to OFF. DTMF groups can only be selected once they have been programmed.</u></i>    |
| 7   | DTMF CALL   | <b>CALL:</b> Hold PTT+CALL to send DTMF encode;<br><i><u>Note: If the M1-M16 memory storage has no PTT ID's set, the DTMF function will be defaulted to OFF. DTMF groups can only be selected once they have been programmed.</u></i> |

## 6.3 Channel Menu Setting

1. Long press the **FUNC** key to enter the MENU list;
2. Short press the **[▲]/[▼]** keys or rotate the volume knob to move the cursor, and press the **[PUSH]** key to enter the CH Para menu;
3. Short press the **[▲]/[▼]** keys or rotate the volume knob to select the desired function option, and press the **[PUSH]** key to enter parameter settings;
4. Press the Back(EMG) button to save and return to the previous menu step by step.

| NO. | LCD display                    | Functional Description   |
|-----|--------------------------------|--|
| 1   | <b>BUSY</b>                    | <b>OFF:</b> Disable Busy Channel Lockout function;<br><b>ON:</b> Enable Busy Channel Lockout function;<br><b>Default:</b> OFF  |
| 2   | <b>RX<br/>CTCSS/DCS</b>        | <b>CTCSS/DCS:</b> RX setup<br><b>OFF:</b> Turn off CTCSS/DCS function;<br><b>CTCSS:</b> 67.0Hz~250.3Hz, Total 38 tones;<br><b>DCS:</b> D023N~D754N, Total 104 codes;<br><b>Default:</b> OFF  |
| 3   | <b>TX<br/>CTCSS/DCS</b>        | <b>CTCSS/DCS:</b> TX setup<br><b>OFF:</b> Turn off CTCSS/DCS function;<br><b>CTCSS:</b> 67.0Hz~250.3Hz, Total 38 tones;<br><b>DCS:</b> D023N~D754N, Total 104 codes;<br><b>Default:</b> OFF  |
| 4   | <b>RX&amp;TX<br/>CTCSS/DCS</b> | <b>CTCSS/DCS:</b> RX+TX setup<br><b>OFF:</b> Turn off CTCSS/DCS function;<br><b>CTCSS:</b> 67.0Hz~250.3Hz, Total 38 tones;<br><b>DCS:</b> D023N~D754N, Total 104 codes;<br><b>Default:</b> OFF   |
| 5   | <b>Add to<br/>Scan</b>         | <b>Add:</b> LCD displays "S", present channel is added to scan list.<br><b>Skip:</b> LCD does not display "S", present channel is not added to scan list.<br><b>Default:</b> Add   |
| 6   | <b>PUBLIC</b>                  | <b>OFF:</b> Choose independent channel menu;<br><b>ON:</b> Choose public channel menu;<br><b>Default:</b> ON<br><br><i><u>Note: When OFF is selected, additional hidden public channel menu will appear. These are the same as shown in 'Section 6.2'.</u></i> |

## 6.4 DTMF Menu Setting

1. Long press the **FUNC** key to enter the MENU list;
2. Short press the [**▲**]/[**▼**] keys or rotate the volume knob to move the cursor, and press the [PUSH] key to enter the DTMF Para menu;
3. Short press the [**▲**]/[**▼**] keys or rotate the volume knob to select the desired function option, and press the [PUSH] key to enter parameter settings;
4. Press the Back(EMG) button to save and return to the previous menu step by step.

| NO. | LCD display              | Functional Description  |
|-----|--------------------------|---|
| 1   | <b>Send Time</b>         | DTMF transmit time, This product offers 50 levels ranging from 10ms~500ms for selection;<br><b>Default:</b> 100ms   |
| 2   | <b>First Digit Time</b>  | First digital delay time, This product offers 11 levels ranging from OFF, 100ms~1000ms for selection;<br><b>Default:</b> 200ms                                    |
| 3   | <b>First Digit Delay</b> | Pre-carrier time, This product offers 25 levels ranging from 100ms~2500ms for selection;<br><b>Default:</b> 300ms   |
| 4   | <b>*and# Tone</b>        | * and # delay time; This product offers 4 levels ranging from OFF, 100ms~1000ms for selection;<br><b>Default:</b> OFF   |
| 5   | <b>D Code Assignment</b> | D code setting time; This product offers 17 levels ranging from OFF, 1s~16s for selection;<br><b>Default:</b> OFF   |
| 6   | <b>DTMF Disp</b>         | <b>ON:</b> Turn off DTMF sending display<br><b>OFF:</b> Turn off DTMF sending display<br><b>Default:</b> ON   |
| 7   | <b>Autodial Memory</b>   | DTMF encode storage list;<br><u>Note: In the DTMF encode storage list (M1-M16), press PUSH to edit DTMF code. then turn channel knob to choose desired value;</u> |

## 6.5 Microphone Menu Setting

1. Long press the **FUNC** key to enter the MENU list;
2. Short press the [**▲**]/[**▼**] keys or rotate the volume knob to move the cursor, and press the [PUSH] key to enter the KEY Para menu;
3. Short press the [**▲**]/[**▼**] keys or rotate the volume knob to select the desired function option, and press the [PUSH] key to enter parameter settings;
4. Press the Back(EMG) button to save and return to the previous menu step by step.

| NO. | LCD display             | Functional Description   |
|-----|-------------------------|--|
| 1   | <b>MicrophoneType</b>   | <b>TYPE1:</b> The microphone is equipped with a standard RJ45 plug;<br><b>TYPE2:</b> The microphone is an optional 4-PIN plug microphone (requires a RJ45 to 4-PIN adaptor cable);<br><b>TYPE3:</b> The microphone is a multifunctional numeric keypad microphone<br><b>Default:</b> TYPE1 |
| 2   | <b>MicrophoneKey PF</b> | Customize menu settings for the microphone, press the PUSH key to enter and select the desired function;<br><b>Default:</b> VOX function   |

## 6.6 Time Setting

1. Long press the **FUNC** key to enter the MENU list;
2. Short press the [**▲**]/[**▼**] keys or rotate the volume knob to move the cursor, and press the [PUSH] key to enter the TIME Para menu;
3. Short press the [**▲**]/[**▼**] keys or rotate the volume knob to select the desired function option, and press the [PUSH] key to enter parameter settings;
4. Press the Back (EMG) button to save and return to the previous menu step by step.

| NO. | LCD display              | Functional Description   |
|-----|--------------------------|--|
| 1   | <b>Clock Setting</b>     | Set the time in hours, minutes, seconds, and rotate the channel switch to modify the values.   |
| 2   | <b>Date Setting</b>      | Set the year, month, and day of the date, rotate the channel switch to modify the value.   |
| 3   | <b>Clock Color</b>       | Time/date color display settings,WHITE, YELLOW, RED, GREEN, CYAN,<br><b>Default:</b> WHITE   |
| 4   | <b>Power OFF Display</b> | <b>CLOCK:</b> When shutting down, turn on the time/date display<br><b>OFF:</b> When shutting down, display the shutdown time/date<br><b>Default:</b> CLOCK |

## 6.7 Radio Version Check

1. Long press the **FUNC** key to enter the MENU list;
2. Short press the [**▲**]/[**▼**] keys or rotate the volume knob to move the cursor, and press the [PUSH] key to enter the Device Info menu;
3. Short press the [**▲**]/[**▼**] keys or rotate the volume knob to select the desired function option for inquiry;
4. Press the Back(EMG) button to save and return to the previous menu step by step.

| NO. | LCD display           | Functional Description                    |
|-----|-----------------------|---|
| 1   | <b>LCD Soft Ver</b>   | Display software version number query     |
| 2   | <b>RF Soft Ver</b>    | Motherboard software version number query |
| 3   | <b>Work Mode</b>      | Current working mode query                |
| 4   | <b>Hardware Ver</b>   | Hardware version number query             |
| 5   | <b>Radio Data Ver</b> | Data date query                           |
| 6   | <b>Last Pro Date</b>  | Last programming date query               |
| 7   | <b>BT Soft Ver</b>    | BT wireless version number query          |

## 6.8 Radio Version Check

1. Long press the **FUNC** key to enter the MENU list;
2. Short press the [**▲**]/[**▼**] keys or rotate the volume knob to move the cursor, and press the [PUSH] key to enter the Device Info menu;
3. Short press the [**▲**]/[**▼**] keys or rotate the volume knob to select the desired function option for inquiry;
4. Press the Back(EMG) button to save and return to the previous menu step by step.

| NO. | LCD display           | Functional Description                    |
|-----|-----------------------|---|
| 1   | <b>LCD Soft Ver</b>   | Display software version number query     |
| 2   | <b>RF Soft Ver</b>    | Motherboard software version number query |
| 3   | <b>Work Mode</b>      | Current working mode query                |
| 4   | <b>Hardware Ver</b>   | Hardware version number query             |
| 5   | <b>Radio Data Ver</b> | Data date query                           |
| 6   | <b>Last Pro Date</b>  | Last programming date query               |
| 7   | <b>BT Soft Ver</b>    | BT wireless version number query          |

## 7. SPECIFICATIONS

| <b>GENERAL</b>                 |   |                |
|--------------------------------|---|----------------|
| Modulation Mode                | AM/FM/USB/LSB/CW/PA   |                |
| Frequency Range                | 26.965-27.405MHz  |                |
| Frequency Tolerance            | ±5.0ppm   |                |
| Input Voltage                  | 12/24V  |                |
| Dimensions(in mm)              | 124(W) x 163(D) x 39(H)   |                |
| Weight                         | 0.668kg   |                |
| Frequency Control              | PLL Synthesizer   |                |
| Operating Temperature Range    | -20° C TO + 55° C   |                |
| Current Drain                  | Transmit  | 8.0A MAX       |
|                                | Receive   | Squelched 0.5A |
|                                | VOL Max   | 0.8A           |
| Antenna Connector              | UHF,SO-239  |                |
| <b>TRANSMITTER</b>             |   |                |
| Power Output                   | AM/FM/CW:4W;SSB:12W   |                |
| Transmission interference      | inferior to 4nW(-54dBm)   |                |
| Frequency Response             | 450-2500Hz  |                |
| Modulated signal distortion    | inferior to 5%  |                |
| Output Impedance               | 50 ohms   |                |
| <b>RECEIVER</b>                |   |                |
| Sensitivity                    | AM: 1.0 $\mu$ V for 10dB(S+N)/N at greater than 1/2watt of audio output.<br>FM: 1.0 $\mu$ V for 20dB (S+N)/N at greater than 1/2 watt of audio output.<br>SSB: 0.25 $\mu$ V for 10dB(S+N)/N at greater than 1/2-watt of audio output. |                |
| IF Frequencies                 | AM/FM: 10.695MHz 1st IF, 455 KHz 2nd IF<br>SSB: 10.695MHz   |                |
| RF Gain Control                | 48dB adjustable   |                |
| Automatic Gain Control(AGC)    | Less than 10dB change in audio output for inputs from 10 $\mu$ V to 100,000 $\mu$ V   |                |
| Squelch                        | Adjustable; threshold less than 0.25 $\mu$ V.<br>Automatic Squelch Control (only AM/FM) 0.5 $\mu$ V   |                |
| ANL                            | Switchable  |                |
| Noise Blanker                  | RF type, effective on AM/FM and SSB   |                |
| Audio Output Power             | 3 watts into 8 ohms   |                |
| Frequency Response             | 300-3000Hz  |                |
| Built-in Speaker               | ohms, round   |                |
| External Speaker(Not Supplied) | 8 ohms, disables internal speaker when connected  |                |